

**New**

# Wireless Sensing High-Power Pneumatic Swing Clamp / Link Clamp

Air Lock / Air Release



High-Power Pneumatic Swing Clamp

model **WHP**



High-Power Pneumatic Link Clamp

model **WCP**

## Wirelessly Detect Unclamp Position

## No External Power Supply

## Required for Sensor

AIR LOCK / AIR RELEASE

**NEW**

# Wireless Sensing High-Power Pneumatic Clamp PAT.P.



High-Power Pneumatic Swing Clamp  
model **WHP**



High-Power Pneumatic Link Clamp  
model **WCP**

## Wirelessly Detect Unclamp Position

## No External Power Supply Required for Sensor

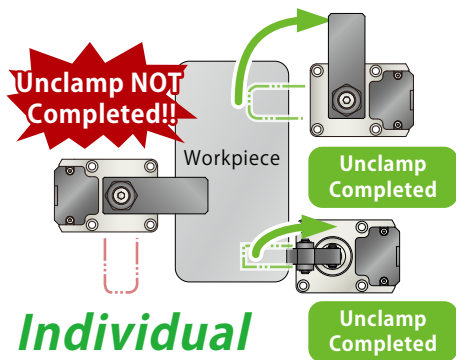

### Individual Detection

Separate unclamp detection is possible for each clamp.



Waterproof Rating

Equivalent to **IPX7**

※ Shows the protection level of the sensor.



Response Time  
**0.1sec.**

Quick Response<sup>※</sup>

※ Compared with our conventional air sensing clamps.

## Minimized Number of Ports

Solution to fixture port shortage.

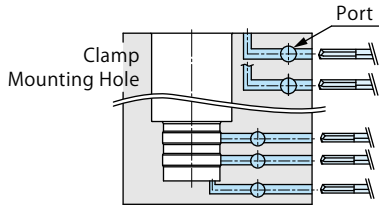

With  
Wireless  
Sensing

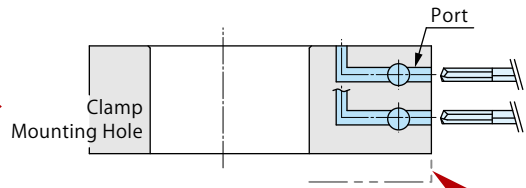

### Conventional Fixture※ : Multiple Ports

Air Port × 2, Air Sensor Port × 2, Vent Port × 1

※Using our conventional air sensing clamp (model WHE-M)

### Air sensor port is not required.

Air Port × 2

Enables a thinner  
and lighter fixture.

## Lower Design • Fixture Cost

Design & machining costs for sensing ports are not required.

※ Image compared with our conventional air sensing clamps.



With  
Wireless  
Sensing



### Conventional※ sensing function needed design and machining costs for ports.

※ For conventional models, please see the "Changes in Sensing Clamps" .

### Fixture is simplified.

## Zero Air Consumption

Detect unclamp position via wireless communication.

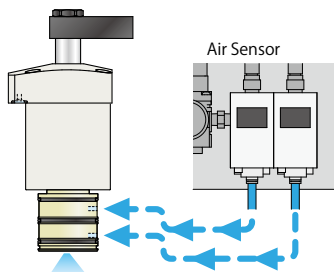

With  
Wireless  
Sensing

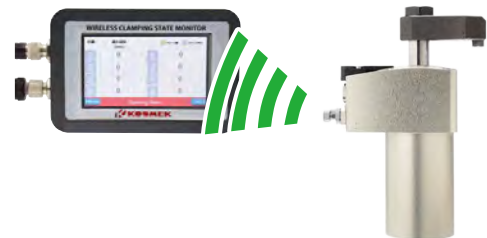

### Consumes air for detection.

※Using our conventional air sensing clamp

### Detects wirelessly, zero air consumption.

### Changes in Sensing Clamps

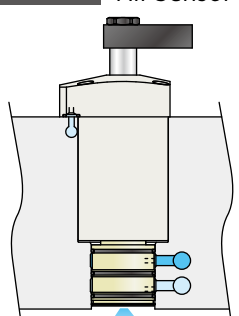
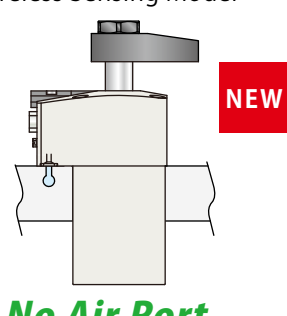
	Conventional Air Sensor Model	Wireless Sensing Model
Model		
Air Consumption	High	<b>Zero</b>
Cylinder Length	Long (High Interference)	<b>Short</b>

Please contact us when considering the wireless sensing clamp.

# Wireless Sensing High-Power Pneumatic Swing Clamp

Model WHP



Wirelessly Detect Unclamp Position.

Powerful clamping force and holding force replacing hydraulics.

Number of Ports is Reduced. No External Power Supply Required for Sensor

PAT.P.

- Detects unclamp position wirelessly.

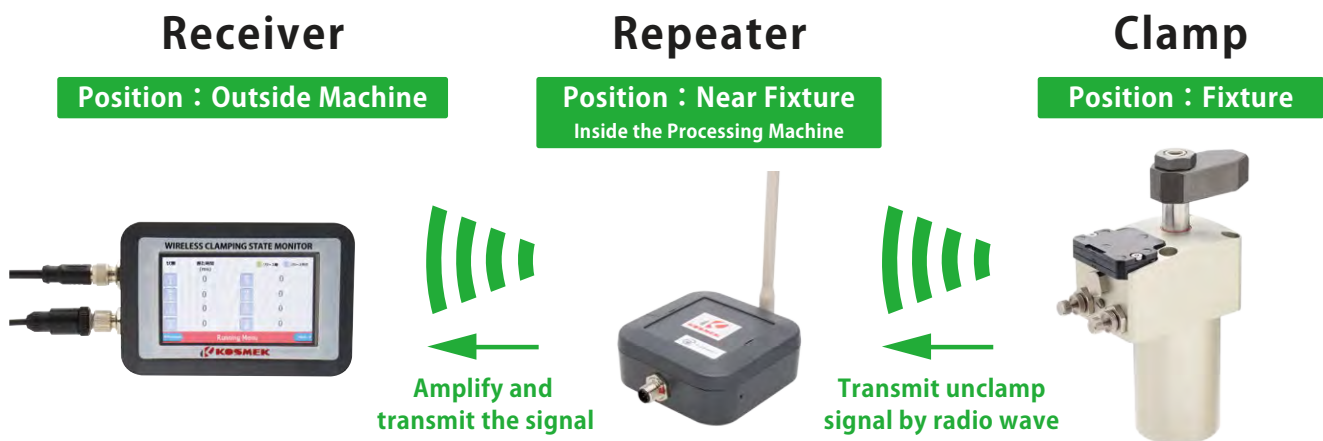

- Holding Force

Powerful holding force that exceeds clamping force allows minimizing the clamping force to the necessary minimum, thereby reducing workpiece distortion.

Holding force is 3 times the clamping force by a mechanical lock.<sup>※1</sup>

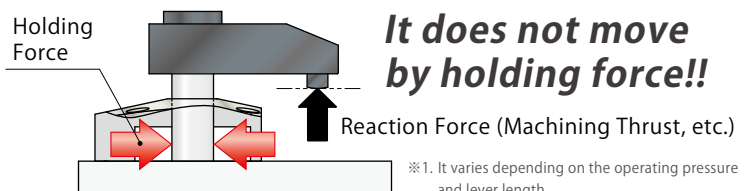

※1. It varies depending on the operating pressure and lever length.

## Action Description

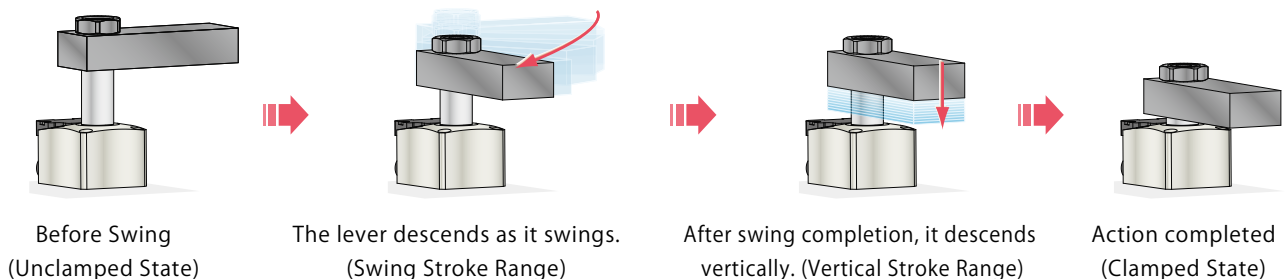

## ● Cross Section ※ This drawing shows Model WHP-2□□-B□.

### Powerful Clamping Force and Holding Force

With mechanical lock, it exerts 3 times higher clamping force than the same size air cylinder, and powerful holding force to withstand large reaction force.

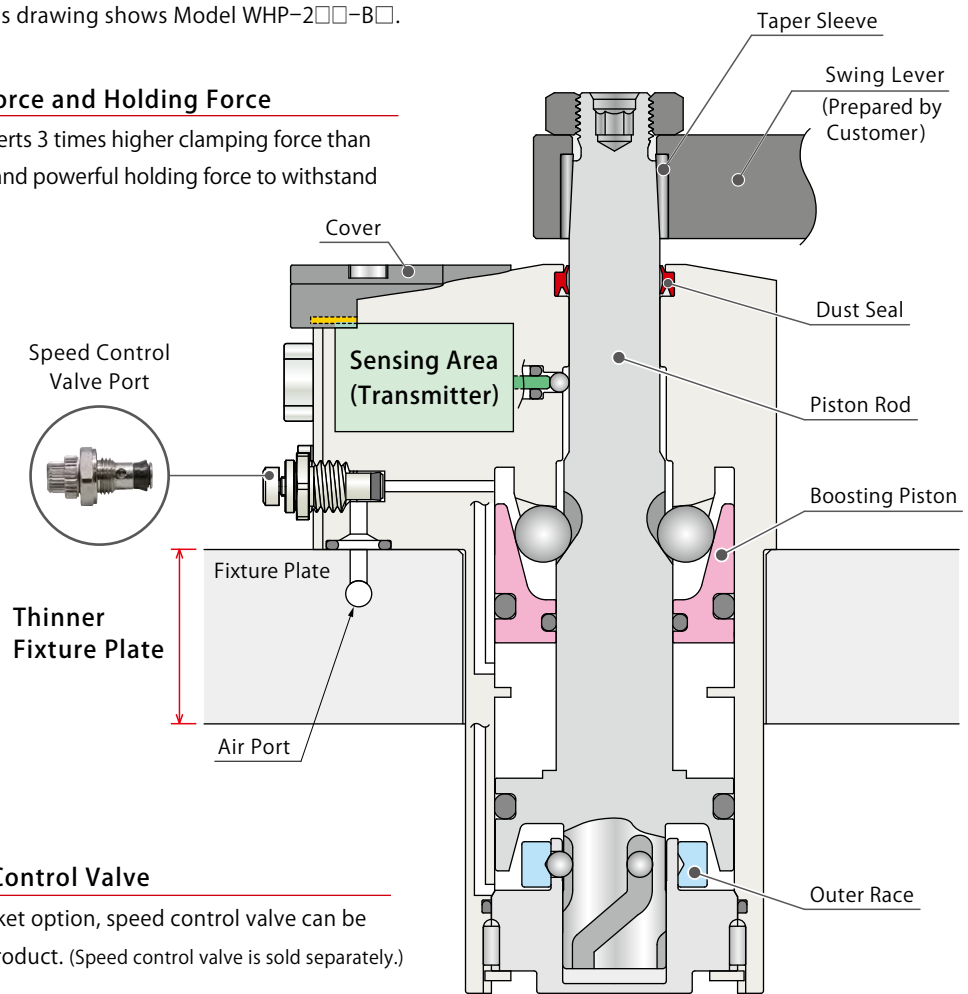

### Direct Mount Speed Control Valve

For piping method A : gasket option, speed control valve can be directly mounted to the product. (Speed control valve is sold separately.)

### Excellent Coolant Resistance

Our exclusive dust seal is designed to protect against high pressure coolant. It also has high durability against chlorine-based coolant by using a sealing material with excellent chemical resistance.

### High Speed and High Endurance with Rotation Mechanism

The resistance created by the swing action is minimized by having the outer race rotate in accordance with the steel ball movement. High endurance is achieved by enlarging rod diameter which decreases torque and by using bigger steel balls and making the lead groove wider. (Position repeatability for swing is within  $\pm 0.5^\circ$ .)

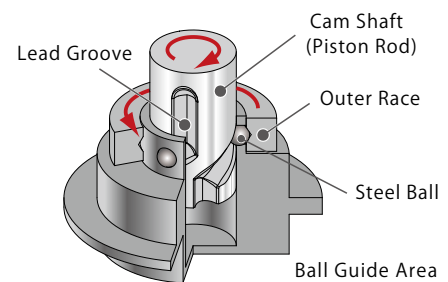

### Zero Air Consumption

Detects unclamp position via wireless communication. Unlike our conventional air sensing clamps, air for action confirmation is not required.



### Minimized Number of Ports • Simple Machining

Integrating ports allows for reducing the number of ports for Rotary Joint and machining for air passage of fixture plate, and simplifying the machining of mounting hole, etc.

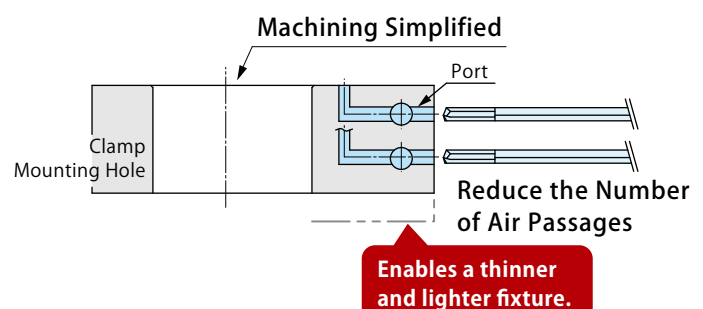

Wireless  
Sensing Clamp

Accessory

Common  
Cautions

Wireless Sensing  
High-Power  
Pneumatic  
Swing Clamp

WHP

Wireless Sensing  
High-Power  
Pneumatic  
Link Clamp

WCP

● Action Description (Internal Structure) ※ The figure shows Model WHP-2□□-B□.

## Unclamp

**Receiver** ※Refer to the website and catalog (model YWA) for further information.



### Unclamp Signal

Distance to receiver : Max. 5m

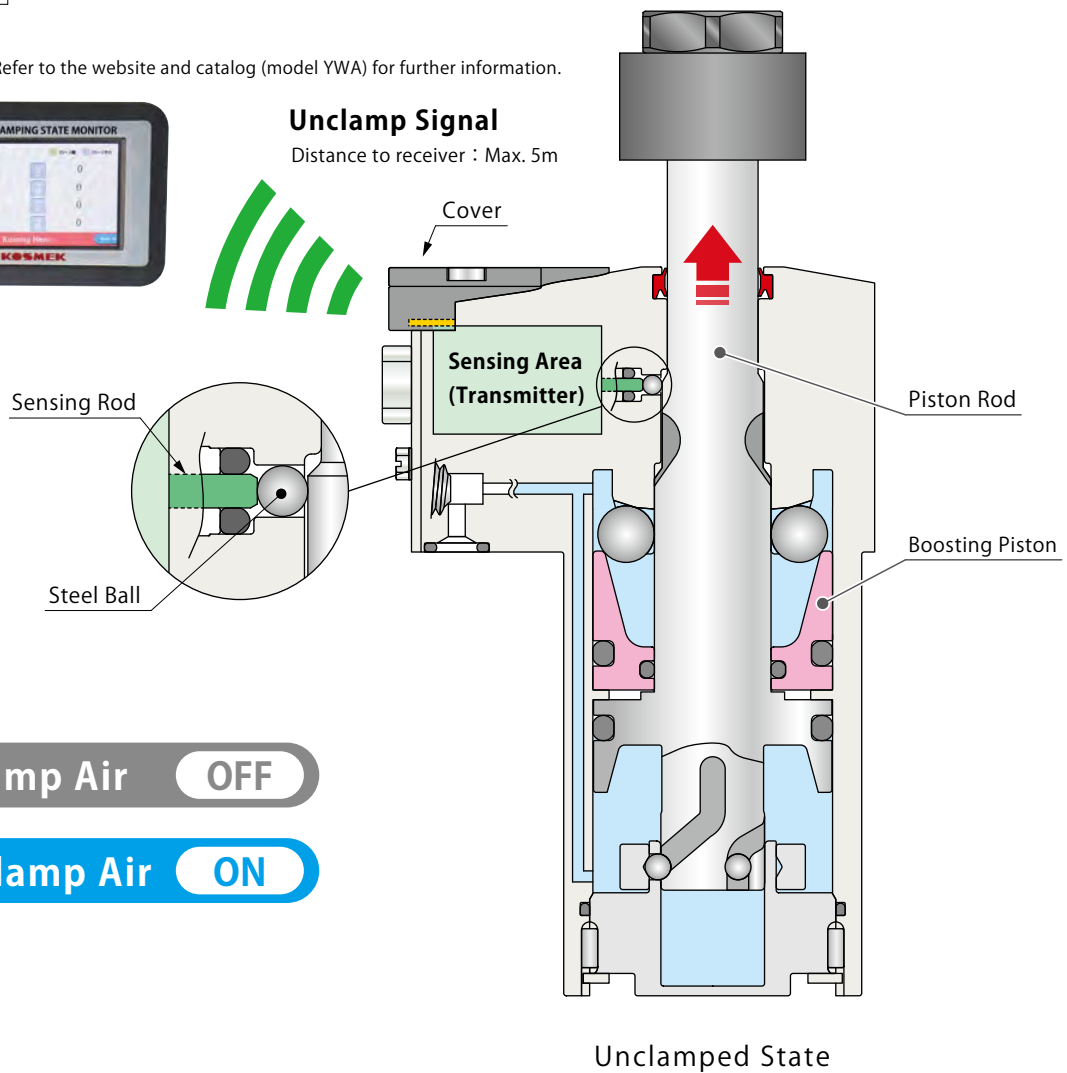

Unclamped State

### ■ Unclamp (During Air Pressure Supply to Unclamping Port)

The piston rod ascends vertically (Vertical Stroke Range : Clamp Stroke + Idle Stroke)



After vertical action is completed, the piston rod ascends as it swings.



When the piston rod pushes the sensing rod via the steel ball before the end of the unclamp stroke, an unclamp signal is transmitted from the sensing area.

### Connecting Multiple Wireless Sensing Clamps

When using multiple wireless sensing clamps, provide an unclamp operating time difference of 100msec (0.1 sec.) or more.

Please check the operating time at the receiver, and adjust the operating time with the speed control valve if it is within 100msec.

Otherwise, signals cannot be received properly due to radio interference.

# Clamp

**Wireless  
Sensing Clamp**

Accessory

Common  
Cautions
**Wireless Sensing  
High-Power  
Pneumatic  
Swing Clamp**

WHP

 Wireless Sensing  
 High-Power  
 Pneumatic  
 Link Clamp

WCP

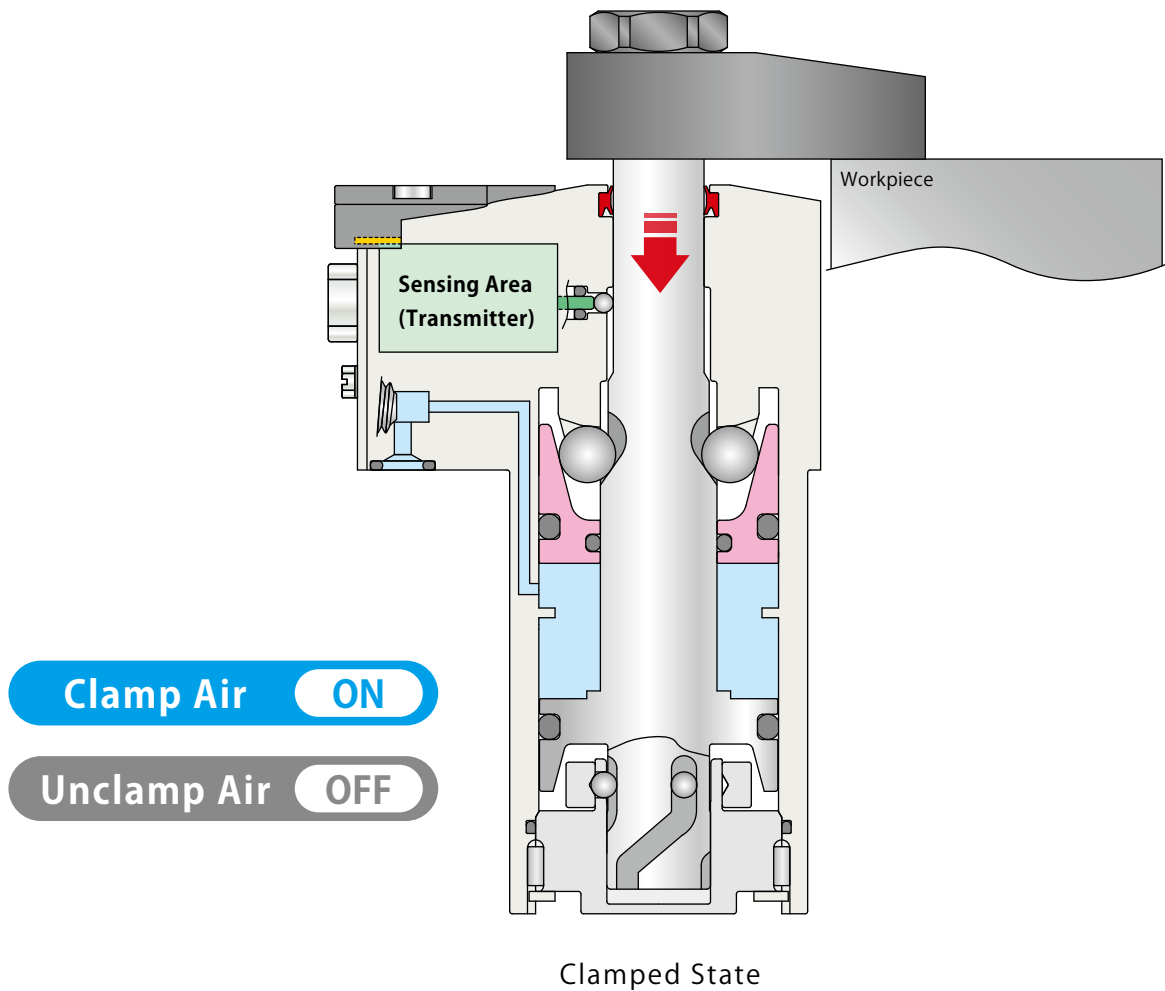

## ■ Clamp (During Air Pressure Supply to Clamping Port)

The piston rod descends as it swings (Swing Stroke Range).



After swing action is completed, the piston rod descends vertically to clamp the workpiece.

At the same time, the boosting piston operates, and powerful clamping and holding forces are generated by the wedge mechanism.

※ Make sure to clamp a workpiece within the clamp stroke range.

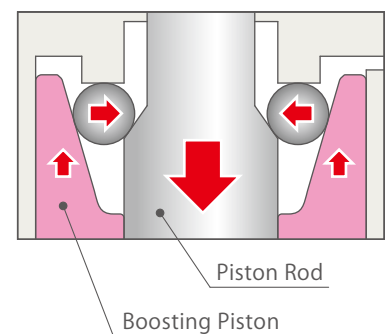

Model No. Indication

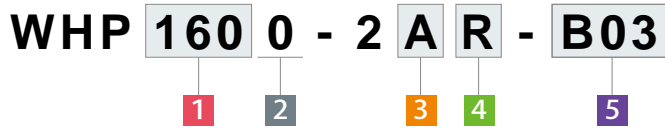

**1** Cylinder Force

- 100** : Cylinder Force 1.0 kN (Air Pressure 0.5MPa)
- 160** : Cylinder Force 1.6 kN (Air Pressure 0.5MPa)
- 250** : Cylinder Force 2.4 kN (Air Pressure 0.5MPa)
- 400** : Cylinder Force 3.9 kN (Air Pressure 0.5MPa)

※ Cylinder force differs from clamping force and holding force.

**2** Design No.

- 0** : Revision Number

**3** Piping Method

- A** : Gasket Option (with Ports for Speed Controller)
- G** : Gasket Option (with R Thread Plug)
- S** : Piping Option (Rc Thread)

※ Speed control valve (BZW) is sold separately.  
Please refer to P. 35.

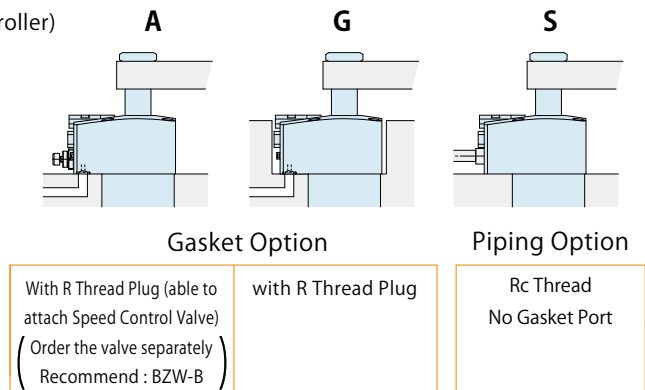

**4** Swing Direction when Clamping

- R** : Clockwise
- L** : Counter-Clockwise

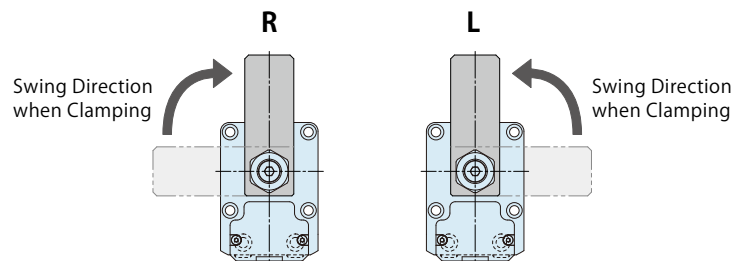

**5** Available Country : Frequency

※ There are restrictions on countries where the product can be used according to radio regulations. Please follow the regulatory requirements of each country.

- B01** : Japan
- B02** : Europe, China
- B03** : United States

## Specifications

Model No.		WHP1000-2□□-B□	WHP1600-2□□-B□	WHP2500-2□□-B□	WHP4000-2□□-B□
Cylinder Force (at 0.5MPa)	kN	1.0	1.6	2.4	3.9
Clamping Force ※1 (Calculation Formula)	kN	$F=(1.8842-0.00346 \times L) \times P$	$F=(3.0603-0.00505 \times L) \times P$	$F=(4.7875-0.00654 \times L) \times P$	$F=(7.6871-0.00947 \times L) \times P$
Holding Force ※1 (Calculation Formula)	kN	$F_k = \frac{4.08 \times P}{1-0.0021 \times L}$	$F_k = \frac{6.628 \times P}{1-0.0012 \times L}$	$F_k = \frac{10.481 \times P}{1-0.0008 \times L}$	$F_k = \frac{16.806 \times P}{1-0.0006 \times L}$
Full Stroke	mm	14.5	15	17.5	19.5
Swing Stroke (90°)	mm	8.5	9	11.5	13.5
Vertical Stroke	mm	6			
(Break down)	Idle Stroke	mm			
	Clamp Stroke ※2	mm			
Swing Angle Accuracy		90° ±3°			
Swing Complete Position Repeatability ※2		±0.75°			
Max. Operating Pressure	MPa	0.5			
Min. Operating Pressure ※3	MPa	0.2			
Withstanding Pressure	MPa	0.75			
Operating Temperature	°C	0 ~ 70 (Sensing Area: ~ 60°C)			
Usable Fluid		Dry Air			
Wireless Sensing (Unclamp Confirmation)	Frequency	5 When selecting <b>B01</b> : 920MHz Band			
		5 When selecting <b>B02</b> : 868MHz Band			
		5 When selecting <b>B03</b> : 902MHz Band			
	Distance to Receiver	Max. 5m ※4			
Sensing Position	ON from 10° swing angle before the unclamp end stroke.				
Waterproof Rating	Equal to IPX7 (When the cover of the sensing area is completely closed.)				

### Notes :

- ※1. F : Clamping Force (kN), F<sub>k</sub> : Holding Force (kN), P : Supply Air Pressure (MPa), L : Distance between the piston center and the clamping point (mm).
- ※2. The specification value of cylinder force, clamping force, holding force and swing completion position repeatability is fulfilled only when clamping within the lock stroke range.  
Please refer to "The specification value is not fulfilled when clamping out of the lock stroke range." on P.17.
- ※3. Minimum pressure to operate the clamp without load.  
The swinging may stop in the middle of action due to the lever shape (Refer to P.17 for "Notes for Lever Design".)
- ※4. The maximum distance when there is no obstruction. Check the radio wave strength displayed on the receiver and consider the installation of the repeater. (Recommended Threshold Value: -85dBm)
  1. Please refer to the external dimensions for cylinder capacity and product weight.

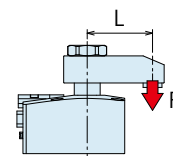

### Wireless Sensing Clamp

Accessory

Common Cautions

### Wireless Sensing High-Power Pneumatic Swing Clamp

WHP

Wireless Sensing High-Power Pneumatic Link Clamp

WCP

Clamping Force Curve

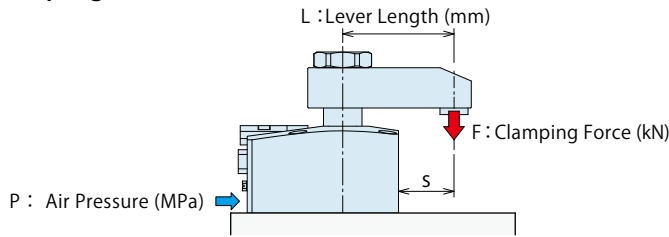

(How to read the clamping force curve)  
 In case of WHP1600 : When supply air pressure P is 0.4MPa and lever length L is 60mm, clamping force becomes about 1.1kN

Notes:

- ※1. F : Clamping Force (kN) , P : Supply Air Pressure (MPa) , L : Lever Length (mm)
- 1. Tables and graphs show the relationship between the clamping force (kN) and supply air pressure (MPa).
- 2. Cylinder force (when L=0) cannot be calculated from the formula of clamping force.
- 3. Values in below charts indicate clamping force when clamping within the clamp stroke range.  
 (Please refer to "The specification value is not fulfilled when clamping out of the clamp stroke range." on P.17.)
- 4. Values in below charts indicate clamping force when the lever locks a workpiece in horizontal position.
- 5. The clamping force varies depending on the lever length. Set the suitable supply air pressure based on the lever length.
- 6. Clamping force in the non-usable range may cause damage and fluid leakage.

<b>WHP1000</b>		Clamping Force Calculation Formula※1 (kN) $F=(1.8842 - 0.00346 \times L) \times P$						Max. Lever Length (mm)
Air Pressure (MPa)	Cylinder Force (kN)	Clamping Force (kN) Non-Usable Range (■)						
		Lever Length L (mm)						
		40	60	80	100	125	150	
0.5	0.98	0.87	0.84	0.80	0.77	0.73	■	125
0.4	0.78	0.70	0.67	0.64	0.62	0.58	0.55	180
0.3	0.59	0.52	0.50	0.48	0.46	0.44	0.41	190
0.2	0.39	0.35	0.34	0.32	0.31	0.29	0.27	190
Max. Operating Pressure (MPa)		0.5	0.5	0.5	0.5	0.5	0.44	

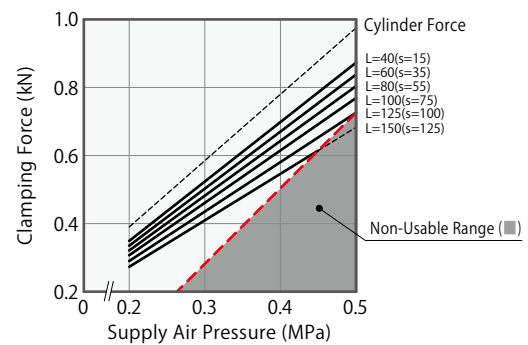

<b>WHP1600</b>		Clamping Force Calculation Formula※1 (kN) $F=(3.0603 - 0.00505 \times L) \times P$						Max. Lever Length (mm)
Air Pressure (MPa)	Cylinder Force (kN)	Clamping Force (kN) Non-Usable Range (■)						
		Lever Length L (mm)						
		40	60	80	100	125	150	
0.5	1.57	1.43	1.38	1.33	1.28	1.22	■	125
0.4	1.25	1.14	1.10	1.06	1.02	0.97	0.92	174
0.3	0.94	0.86	0.83	0.80	0.77	0.73	0.69	200
0.2	0.63	0.57	0.55	0.53	0.51	0.49	0.46	200
Max. Operating Pressure (MPa)		0.5	0.5	0.5	0.5	0.5	0.44	

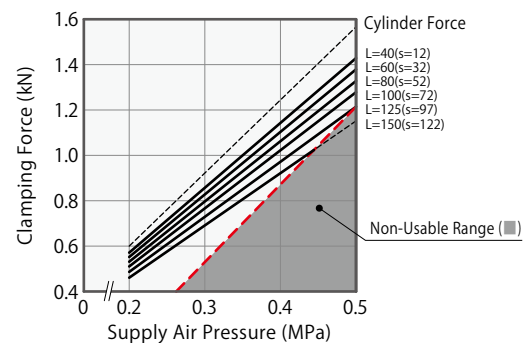

<b>WHP2500</b>		Clamping Force Calculation Formula※1 (kN) $F=(4.7875 - 0.00654 \times L) \times P$						Max. Lever Length (mm)
Air Pressure (MPa)	Cylinder Force (kN)	Clamping Force (kN) Non-Usable Range (■)						
		Lever Length L (mm)						
		60	80	100	125	150	200	
0.5	2.44	2.20	2.13	2.07	1.99	1.90	■	170
0.4	1.96	1.76	1.71	1.65	1.59	1.52	1.39	245
0.3	1.47	1.32	1.28	1.24	1.19	1.14	1.04	270
0.2	0.98	0.88	0.85	0.83	0.79	0.76	0.70	270
Max. Operating Pressure (MPa)		0.5	0.5	0.5	0.5	0.5	0.45	

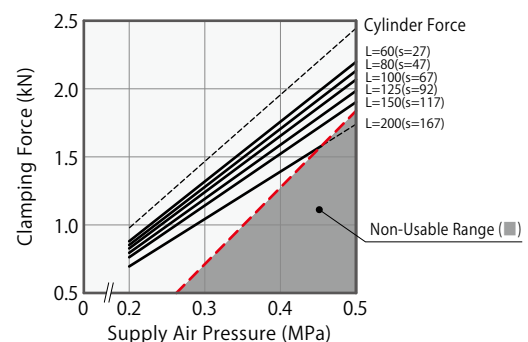

<b>WHP4000</b>		Clamping Force Calculation Formula※1 (kN) $F=(7.6871 - 0.00947 \times L) \times P$						Max. Lever Length (mm)
Air Pressure (MPa)	Cylinder Force (kN)	Clamping Force (kN) Non-Usable Range (■)						
		Lever Length L (mm)						
		60	80	100	150	200	250	
0.5	3.86	3.56	3.46	3.37	3.13	2.90	■	230
0.4	3.09	2.85	2.77	2.70	2.51	2.32	2.13	330
0.3	2.32	2.14	2.08	2.02	1.88	1.74	1.60	330
0.2	1.54	1.42	1.39	1.35	1.25	1.16	1.06	330
Max. Operating Pressure (MPa)		0.5	0.5	0.5	0.5	0.5	0.48	

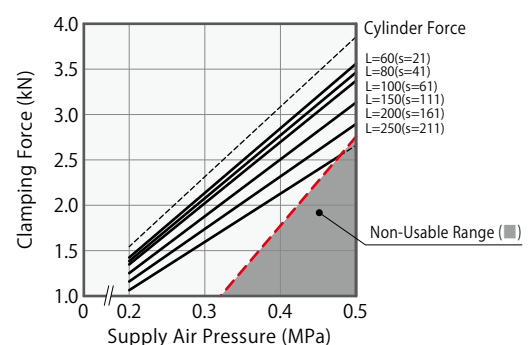

## ● Holding Force Curve

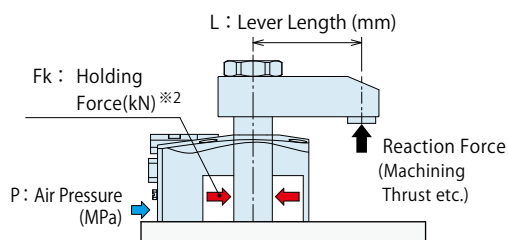

(Ex.1) In case of WHP1600 :

When supply air pressure P is 0.3MPa and lever length L is 50mm, holding force becomes about 2.1kN.

(Ex.2) In case of WHP1600 : When supply air pressure P is 0.3MPa and lever length L is 100mm, the calculated value is at the point A but it is above the rated value. In this case, the value of intersection B on the rated value becomes the holding force that counters the reaction force, and it becomes about 1.5kN.

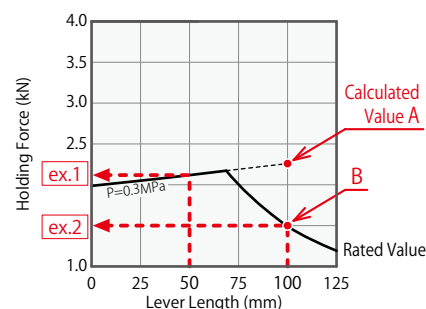

Notes: ※2. Holding force is the force that counters the reaction force in the clamping state, and differs from clamping force.

Please keep in mind that it can produce displacement depending on lever rigidity even if the reaction force is lower than holding force. (If slight displacement is also not allowed, please keep the reaction force beyond clamping force from being applied.)

※3. Fk : Holding Force (kN) , P : Supply Air Pressure (MPa) , L : Lever Length (mm).

When the calculated holding force exceeds the rated value in the graph, the holding force becomes the rated value.

- Tables and graphs show the relationship between the holding force (kN) and lever length (mm).
- Values in below charts indicate holding force when clamping within the clamp stroke range. (Please refer to "The specification value is not fulfilled when clamping out of the clamp stroke range." on P.17.)
- Values in below charts indicate holding force when the lever locks a workpiece in horizontal position.
- The holding force varies depending on the lever length. Set the suitable supply air pressure based on the lever length.
- The reaction force exceeding the holding force shown in the table and the graph may cause damage and fluid leakage.

### WHP1000

$$\text{Holding Force Formula}^{※3} \text{ (kN)} \quad Fk = \frac{4.08 \times P}{1 - 0.0021 \times L}$$

( Fk ≤ Rated Value )

Air Pressure (MPa)	Holding Force (kN) Non-Usable Range (■)					
	Lever Length L (mm)					
	40	60	80	100	125	150
0.5	2.23	1.51	1.13	0.91	0.73	■
0.4	1.78	1.51	1.13	0.91	0.73	0.61
0.3	1.34	1.40	1.13	0.91	0.73	0.61
0.2	0.89	0.93	0.98	0.91	0.73	0.61

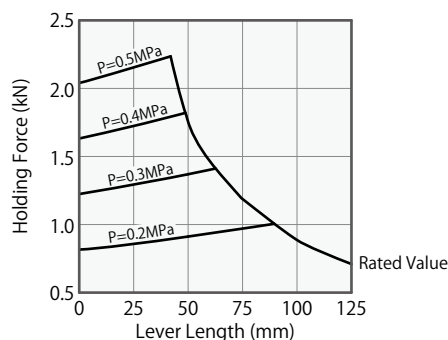

### WHP1600

$$\text{Holding Force Formula}^{※3} \text{ (kN)} \quad Fk = \frac{6.628 \times P}{1 - 0.0012 \times L}$$

( Fk ≤ Rated Value )

Air Pressure (MPa)	Holding Force (kN) Non-Usable Range (■)					
	Lever Length L (mm)					
	40	60	80	100	125	150
0.5	3.48	2.53	1.90	1.52	1.22	■
0.4	2.79	2.53	1.90	1.52	1.22	1.01
0.3	2.09	2.14	1.90	1.52	1.22	1.01
0.2	1.39	1.43	1.47	1.51	1.22	1.01

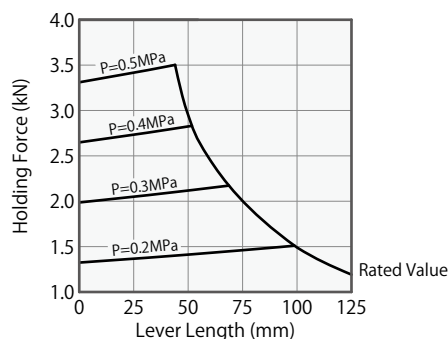

### WHP2500

$$\text{Holding Force Formula}^{※3} \text{ (kN)} \quad Fk = \frac{10.481 \times P}{1 - 0.0008 \times L}$$

( Fk ≤ Rated Value )

Air Pressure (MPa)	Holding Force (kN) Non-Usable Range (■)					
	Lever Length L (mm)					
	60	80	100	125	150	200
0.5	5.21	3.91	3.12	2.50	2.08	■
0.4	4.40	3.91	3.12	2.50	2.08	1.56
0.3	3.30	3.36	3.12	2.50	2.08	1.56
0.2	2.20	2.24	2.28	2.33	2.08	1.56

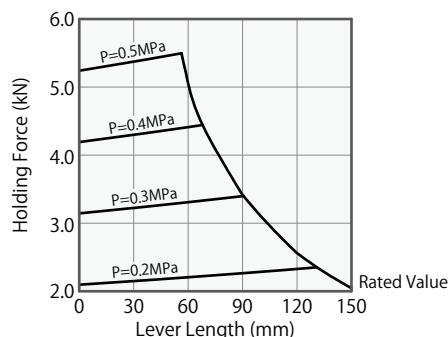

### WHP4000

$$\text{Holding Force Formula}^{※3} \text{ (kN)} \quad Fk = \frac{16.806 \times P}{1 - 0.0006 \times L}$$

( Fk ≤ Rated Value )

Air Pressure (MPa)	Holding Force (kN) Non-Usable Range (■)					
	Lever Length L (mm)					
	60	80	100	150	200	250
0.5	8.72	7.92	6.34	4.22	3.17	■
0.4	6.97	7.06	6.34	4.22	3.17	2.53
0.3	5.23	5.30	5.36	4.22	3.17	2.53
0.2	3.49	3.53	3.58	3.69	3.17	2.53

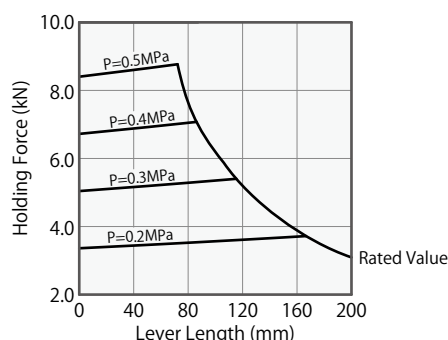

● Allowable Swing Time Graph

Adjustment of Swing Time

The graph shows allowable swing time against the moment of inertia of a lever. An operation time should be longer than the operation time shown in the graph.

Excessive action speed can reduce stopping accuracy and damage internal components.

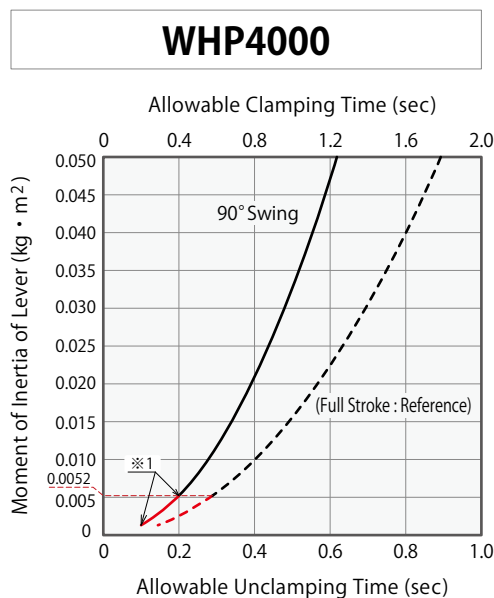
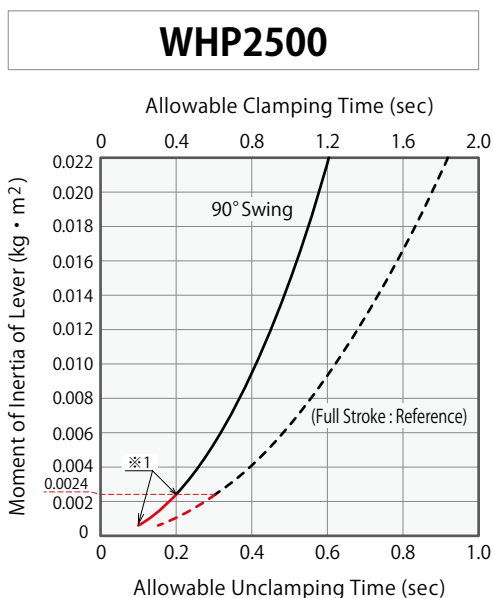
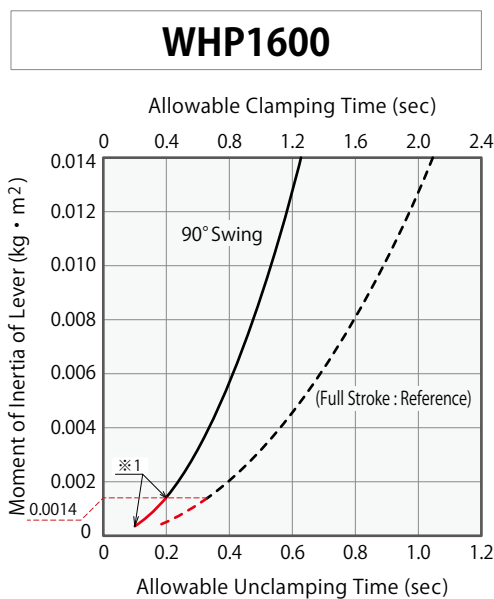
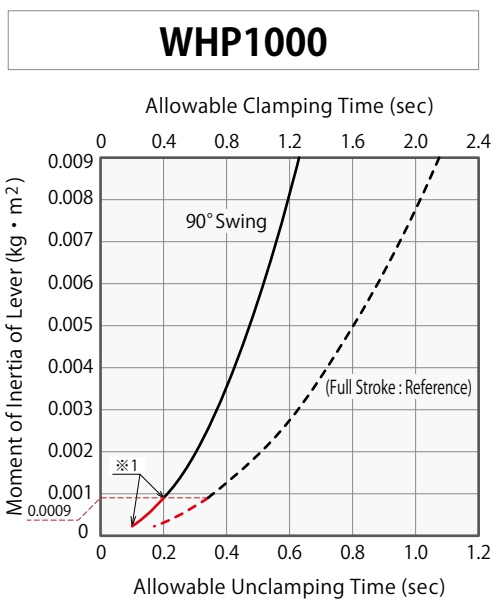
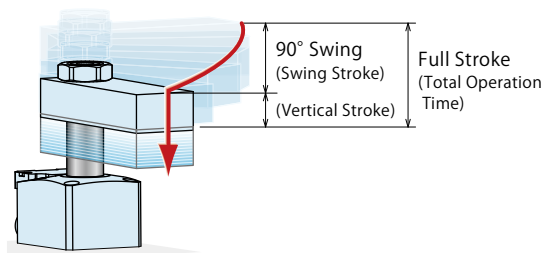

Notes:

- ※1. For any moment of inertia of a lever, the minimum 90° swing time should be 0.2 sec.
  1. Lever with a large inertia sometimes does not work depending on supply air pressure, air flow rate and lever mounting position.
  2. For speed adjustment of clamp lever, please use meter-out flow control valve. In case of meter-in control, the clamp lever may be accelerated by its own weight during swinging motion (clamp mounted horizontally) or the piston rod may be moving too fast. Please refer to P.17 for speed adjustment.
  3. Please contact us if operational conditions differ from those shown on the graphs.

(How to read the allowable swing time graph)

In case of WHP1600

The moment of inertia of a lever :  $0.005\text{kg}\cdot\text{m}^2$

①  $90^\circ$  Swing Time when Clamping : About 0.76 sec or more

②  $90^\circ$  Swing Time when Unclamping : About 0.38 sec or more

③ Total Clamp Operation Time : About 1.27 sec or more

④ Total Unclamp Operation Time : About 0.63 sec or more

1. The total operation time on the graph represents the allowable operation time when fully stroked.

Model →

WHP1600

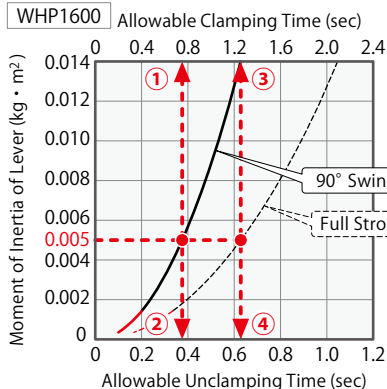

### How to Calculate the Moment of Inertia (Estimated)

I : Moment of Inertia ( $\text{kg}\cdot\text{m}^2$ )    L, L<sub>1</sub>, L<sub>2</sub>, K, b : Length (m)    m, m<sub>1</sub>, m<sub>2</sub>, m<sub>3</sub> : Mass (kg)

- ① For a rectangular plate (cuboid), the rotating shaft is vertically on one side of the plate.

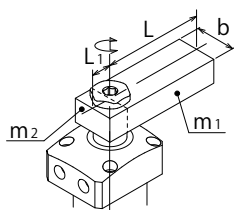

$$I = m_1 \frac{4L^2 + b^2}{12} + m_2 \frac{4L_1^2 + b^2}{12}$$

- ② For a rectangular plate (cuboid), the rotating shaft is vertically on the gravity center of the plate.

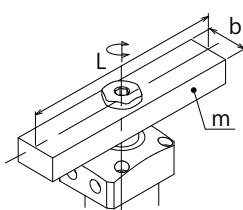

$$I = m \frac{L^2 + b^2}{12}$$

- ③ Load is applied on the lever front end.

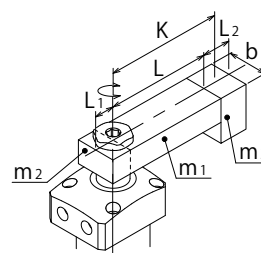

$$I = m_1 \frac{4L^2 + b^2}{12} + m_2 \frac{4L_1^2 + b^2}{12} + m_3 K^2 + m_3 \frac{L_2^2 + b^2}{12}$$



## Model No. Indication

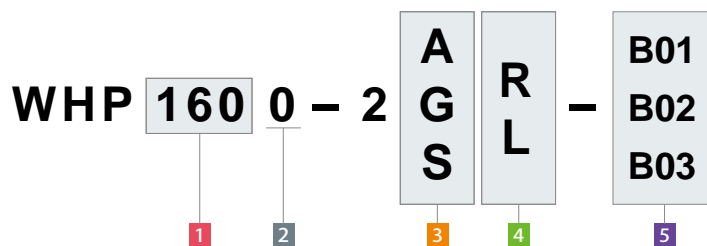

(Format Example : WHP1000-2AR-B02,  
WHP2500-2SL-B03)

- 1 Cylinder Force
- 2 Design No.
- 3 Piping Method
- 4 Swing Direction when Clamping
- 5 Available Country : Frequency

Wireless  
Sensing Clamp

Accessory

Common  
Cautions

Wireless Sensing  
High-Power  
Pneumatic  
Swing Clamp

WHP

Wireless Sensing  
High-Power  
Pneumatic  
Link Clamp

WCP

## External Dimensions and Machining Dimensions for Mounting

(mm)

Model No.	WHP1000-2□□-B□	WHP1600-2□□-B□	WHP2500-2□□-B□	WHP4000-2□□-B□	
Full Stroke	14.5	15	17.5	19.5	
Swing Stroke (90°)	8.5	9	11.5	13.5	
Vertical Stroke	6				
(Break down)	Idle Stroke	2			
	Clamp Stroke※9	4			
Recommended Stroke	11.5	12	14.5	16.5	
A	151.5	158.5	181.5	201.5	
B	71.5	76	83	92	
C	50	56	66	78	
D	46	54	64	77	
E	112.5	116.5	132	144	
Eu	39	42	49.5	57.5	
F	68.5	72.5	88	100	
Fu	83	86	93.5	101.5	
H	46.5	48	50	53	
J	25	28	33	39	
K	39	45	53	65	
L	103	107	112	122	
M	10	11	11	11	
Nx	39.5	41	43	46	
Ny	14	15	16	20	
S	35	34	32	31	
T	16.5	17	19.5	21.5	
U	14	16	20	25	
V	12	14	17	21	
W	10.5	11	13	15	
X (Nominal × Pitch)	M12×1.5	M14×1.5	M16×1.5	M22×1.5	
Y	5	5	6	8	
Z (Chamfer)	R5	R5	R6	R6	
AA	19	22	24	32	
AB	6.5	7	8	10	
AC	21.2	24.5	26.5	35.5	
AD	9	9	11	11	
AE	5.5	5.5	6.8	6.8	
BA	13	15	18	22	
BB	16	18	22	28	
CA	5	6	8	10	
CB	4.5	6.5	5.5	9.5	
CC	4	4	4	6	
EA (Nominal × Pitch)	M5×0.8	M5×0.8	M6×1	M6×1	
Cylinder	Clamp	21.8	35.5	61.3	103.8
	Unclamp	25.5	40.3	69.2	117.6
Capacity cm <sup>3</sup>					
Weight※10 kg	1.0	1.3	2.0	3.2	

Notes :

※ 9. The specification value of cylinder force, clamping force, holding force and swing completion position repeatability is fulfilled only when clamping within the clamp stroke range.

(The specification value is not fulfilled when clamping within the range of swing stroke and idle stroke.)

※ 10. It shows the weight of single swing clamp including taper sleeve and nut.



## Accessory : Material Swing Lever for Taper Lock Lever

Corresponding Model No.

# WHZ 160 0 - T

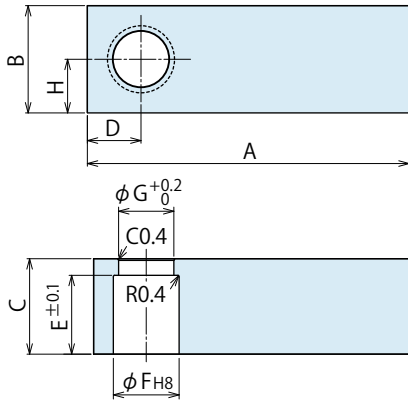
Size  
(Refer to the table.)Design No.  
(Revision Number)

Model No.	WHZ1000-T	WHZ1600-T	WHZ2500-T	WHZ4000-T
Corresponding Model No.	WHP1000-2□□-B□	WHP1600-2□□-B□	WHP2500-2□□-B□	WHP4000-2□□-B□
A	90	125	150	170
B	25	28	34	45
C	16	18	22	26
D	12.5	14	17	23
E	13	15	18	22
F	16 <sup>+0.027</sup> <sub>0</sub>	18 <sup>+0.027</sup> <sub>0</sub>	22 <sup>+0.033</sup> <sub>0</sub>	28 <sup>+0.033</sup> <sub>0</sub>
G	13	15	17	23.5
H	12.5	14	17	22.5

Notes :

1. Material : S50CH Surface Finishing : Alkaline Blackening
2. If necessary, the front end should be additionally machined and finished.
3. When determining the phase, refer to taper lock lever design dimensions for each model for the additional machining.

Wireless  
Sensing Clamp

Accessory

Common  
CautionsWireless Sensing  
High-Power  
Pneumatic  
Swing Clamp

WHP

Wireless Sensing  
High-Power  
Pneumatic  
Link Clamp

WCP

**Cautions**

**Notes for Design**

- 1) Check Specifications
  - Please use each product according to the specifications.
- 2) Radio Regulations
  - There are restrictions on countries where the product can be used according to radio regulations. Please follow the regulatory requirements of each country. (Ex.) WHP □ - 2□□ - B02/B03 can be used in United States.

**Regarding WHP □ - 2□□ - B02/B03**

- At shipment, the signal transmission is in a disabled state, with the function stop nut attached. When enabling signal transmission, please remove the "function stop nut" before use.

**Signal Transmission Function OFF Setting**

- If it is absolutely necessary to operate this product in a country other than the available country, please disable the signal transmission function using the following settings.  
By attaching the "function stop nut" and fixing the sensing rod to prevent movement, the signal transmission function can be stopped.

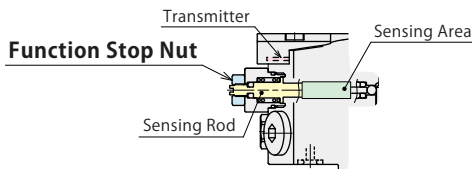

※ 5 Available Country : B01 does not support this function. (Please contact us separately if necessary.)

**Notes for Circuit Design**

- Ensure there is no possibility of supplying air pressure to the clamp port and the unclamp port simultaneously. Improper circuit design may lead to malfunctions and damages.

**Swing lever should be designed to make the moment of inertia small.**

- Large moment of inertia will degrade the lever's stopping accuracy and cause undue wear to the clamp. Additionally, the clamp may not function, depending on supplied air pressure and lever mounting position.
- Set the swing time after the moment of inertia is calculated. Refer to "Allowable Swing Time Graph" and make sure to operate clamps within the allowable operation time.
- If supplying a large amount of air just after installation, action time will be extremely fast leading to severe damage on the clamp. Set the speed controller (Meter-in) and gradually supply air pressure.

**Protect the exposed area of the piston rod when using on a welding fixture.**

- If spatter attaches to the sliding surface it could lead to malfunction and fluid leakage.

**When clamping on a sloped surface of the workpiece**

- Make sure the clamping surface and the mounting surface of the clamp are parallel.

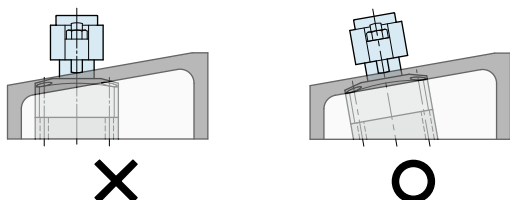

**Swing Speed Adjustment**

- Adjust the speed following "Allowable Swing Time Graph". If the clamp operates too fast the parts will be worn out leading to premature damage and ultimately complete equipment failure.
- Install a speed control valve (meter-out) and gradually control the flow rate from the low-speed side (small flow) to the designated speed. Controlling from the high-speed side (large flow) causes excessive surge pressure or overload to the clamp leading to damage of a machine or device.

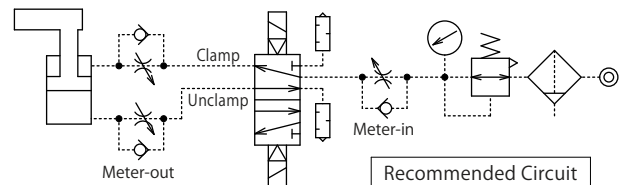

- When using multiple wireless sensing clamps, provide an unclamping time difference of 100msec (0.1 sec.) or more. Simultaneous operation may cause radio interference, which may result in failure to receive unclamp signals properly. For adjusting the unclamp operation, please use a speed control valve.

**Notes for Lever Design**

- Please design a lever as light as possible, and it should be no larger than necessary. The clamp may not function depending on supply air pressure, mounting position and shape of the lever. If using a large lever in the mounting position as shown below, it may stop in the middle of swing action. Please use a lever with (Lever Weight W) × (Gravity Center S) lighter than shown in the following table.

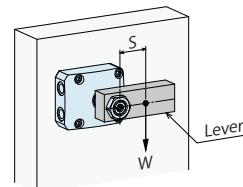

Model No.	(Lever Weight W) × (Gravity Center S) (N·m)
WHP1000	0.10
WHP1600	0.20
WHP2500	0.45
WHP4000	0.90

**The specification value is not fulfilled when clamping out of the clamp stroke range.**

- The mechanical lock function will not work when clamping within the range of swing stroke and idle stroke, and the specification value of cylinder force, clamping force, holding force and swing completion position repeatability will not be fulfilled.

The actual stroke of the piston that descends from the unclamp-end to clamp-end should be designed to have the same value as the recommended stroke listed in the external dimensions.

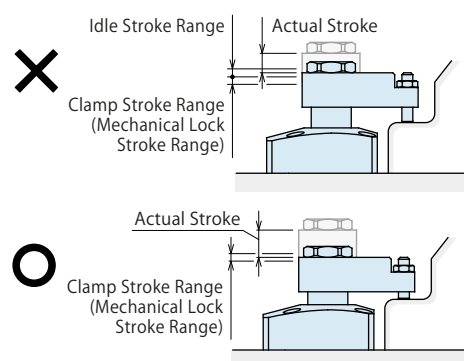

## Notes for Usage

- Do not cover the top surface of the sensing area with metal objects (chips, sludge, etc.). It may obstruct radio wave transmission. The cover is made of plastic material and should be protected from chips.

## Installation Notes

### 1) Check the Usable Fluid

- Please provide filtered clean dry air. (Install a drain removing device.)
- Oil supply with a lubricator, etc. is not necessary. Oil supply with a lubricator may cause loss of the initial lubricant, and the operation under low pressure/speed may be unstable. (When using secondary lubricant, please supply lubricant continuously. Otherwise, the initial grease applied from KOSMEK will be removed from the secondary lubricant.)

### 2) Preparation before Piping

- The pipeline, piping connector and fixture circuits should be cleaned by thorough flushing. The dust and cutting chips in the circuit may lead to fluid leakage and malfunction.
- There is no filter provided with this product which prevents contamination in the circuit.

### 3) Applying Sealing Tape

- Wrap with tape 1 to 2 times following the screw direction.
- Pieces of the sealing tape can lead to air leakage and malfunction.
- When piping, be careful that contaminants such as sealing tape do not enter in products.

### 4) Installation of the Product

- When mounting the clamp, use four hexagonal socket bolts (with tensile strength of 12.9) and tighten them with the torque shown in the table below. Tightening with greater torque than recommended can dent the seating surface or break the bolt.

Model No.	Mounting Bolt Size	Tightening Torque (N·m)
<b>WHP1000</b>	M5×0.8	6.3
<b>WHP1600</b>	M5×0.8	6.3
<b>WHP2500</b>	M6×1	10
<b>WHP4000</b>	M6×1	10

### 5) Installation of the Speed Control Valve

- Tightening torque for installing speed control valve is 5 to 7 N·m.

### 6) Installation / Removal of the Swing Lever

- Oil or debris on the tightened parts of the lever, taper sleeve or piston rod may cause the rod to loosen. Please clean them thoroughly before installation.
- Tighten the tightening bolt of swing lever with the torque shown below.

Model No.	Mounting Bolt Size	Tightening Torque (N·m)
<b>WHP1000</b>	M12×1.5	17 ~ 20
<b>WHP1600</b>	M14×1.5	21 ~ 25
<b>WHP2500</b>	M16×1.5	33 ~ 40
<b>WHP4000</b>	M22×1.5	84 ~ 100

- If the piston rod is subjected to excessive torque or shock, the rod or the internal mechanism may be damaged. Observe the following points to prevent such shock.

### Installation Procedure

- With a clamp positioned to a jig, determine the lever position, and tighten the nut for fixing the lever (temporal tightening).

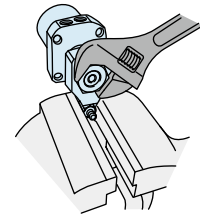

- Remove the clamp from the jig, fix the lever with a machine vise etc., and tighten the nut.

- If tightening the nut with the clamp positioned to the jig, use a wrench to the hexagon part of piston rod, or fix the lever with a spanner.

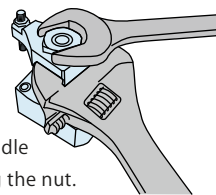

It is best to bring the lever to the middle of the swing stroke before tightening the nut.

### Removal Procedure

- While the clamp is on the jig or vise, use a hex wrench to bring the lever to the middle of the swing stroke and then loosen the nut.

- Loosen the nut after securing the lever two or three turns then remove the lever with a puller without any rotational torque applied on the piston rod.

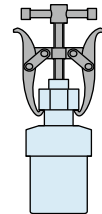

### 7) Initial Connection Settings for the Receiver

During setup, it is necessary to perform the initial connection settings between the clamp and the receiver. (For detailed instructions, refer to the instruction manual of receiver YWA.)

### 8) Cautions for Repeater Installation

The maximum distance between the clamp and the receiver is 5 meters. Check the radio wave strength displayed on the receiver and consider the installation of the repeater. (Recommended Threshold : -85dBm)  
It is recommended to install the repeater in locations such as the upper part inside the processing machine, where it is less likely to be exposed to coolant or chips.

### Guidelines for Repeater Installation

- When the receiver cannot be installed at a height of 2 meters or more.
- When there is a radio wave obstruction between the clamp and the receiver.
- When the clamp and the receiver are more than 3 meters apart.

# Air Flow Control Valve

Model BZW



Directly mounted to clamps, easy adjusting

- **Directly Mounted to Clamps**

BZW is the flow control valve for Rc thread that enable to mount to the piping method : option -A of WHP/WCP. It is best used in a circuit where the flow control valve cannot be mounted or if necessary to synchronize individual speed.

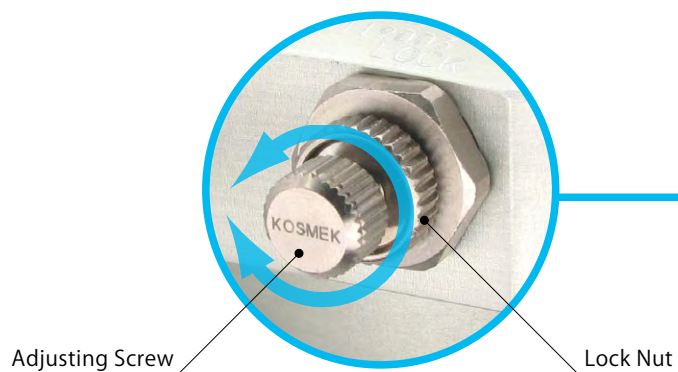

## Corresponding Product Model

Clamps	BZW Model No.	Clamp Model No.
Wireless Sensing High-Power Pneumatic Link Clamp	BZW0100- <b>A</b>	WCP □ 0-2 <b>A</b> □
Wireless Sensing High-Power Pneumatic Swing Clamp	BZW0100- <b>B</b>	WHP □ 0-2 <b>A</b> □

Corresponding to piping method -A option.

※ When mounting BZW to the piping method G, take off R thread plug and remove the sealing tape not to get inside the cylinder.

### Model No. Indication

# BZW 010 0 - B

Control Method  
**B** : Meter-out  
**A** : Meter-in

Design No.  
**0** : Revision Number

R Thread Size  
**010** : Rc1/8

### Specifications

Model No.	BZW0100-B	BZW0100-A
Control Method	Meter-out	Meter-in
Operating Pressure MPa	0.1 ~ 1.0	
Withstanding Pressure MPa	1.5	
Adjusting Screw Number of Rotations	10	
Tightening Torque N·m	5 ~ 7	
Weight g	13	
Corresponding Model No.	WHP□-2A□-B□	WCP□-2A□-B□

### Circuit Symbol

**BZW0100-B : Meter-out**

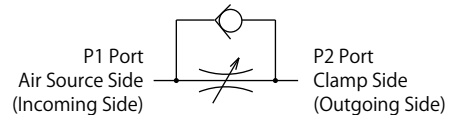

**BZW0100-A : Meter-in**

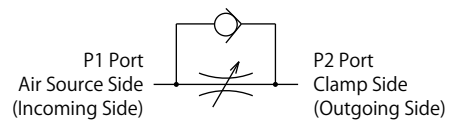

### External Dimensions

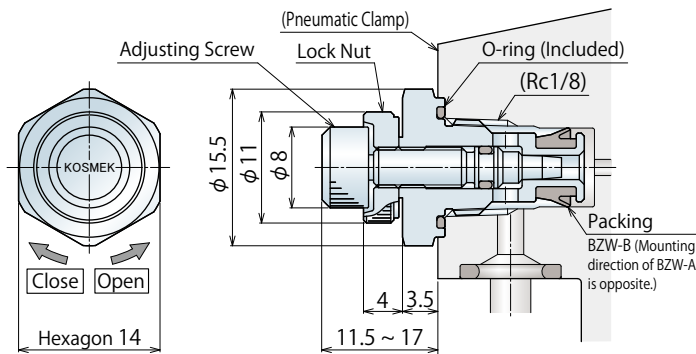

### Flow Rate Graph

**BZW0100-B/BZW0100-A common**

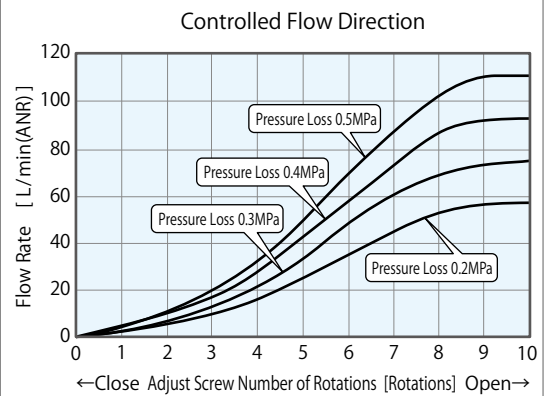

### Machining Dimensions of Mounting Area

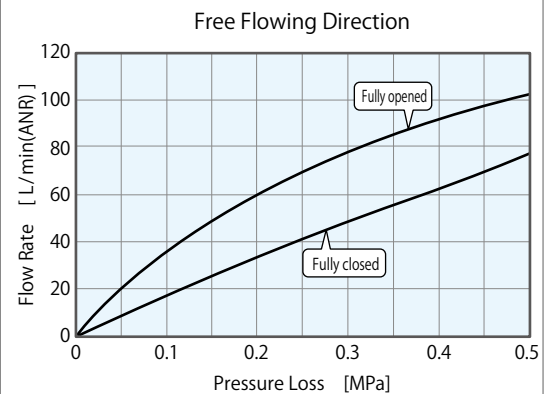
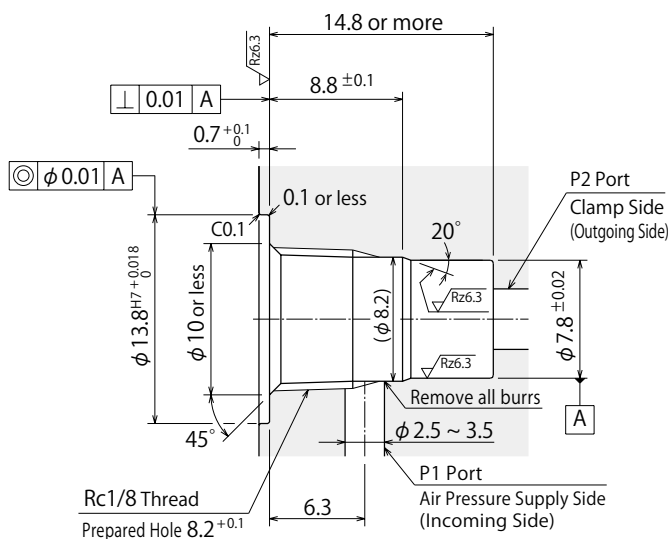

Notes :

1. Since the  $\sqrt{R26.3}$  area is sealing part, be careful not to damage it.
2. No cutting chips or burr should be at the tolerance part of machining hole.
3. As shown in the drawing, P1 port is used as the air supply side and P2 port as the clamp side.

## ⓘ Cautions

### ● Notes on Handling

- 1) It should be operated by qualified personnel.
  - Machines and devices with hydraulic and pneumatic products should be operated and maintained by qualified personnel.
- 2) Do not operate or remove the product unless the safety protocols are ensured.
  - ① Machines and devices can only be inspected or prepared when it is confirmed that the safety devices are in place.
  - ② Before the product is removed, make sure that the above-mentioned safety devices are in place. Shut off the pressure and power source, and make sure no pressure exists in the air and hydraulic circuits.
  - ③ After stopping the product, do not remove until the temperature drops.
  - ④ Make sure there is no trouble/issue in the bolts and respective parts before restarting a machine or device.
- 3) Do not touch a clamp (cylinder) while it is working. Otherwise, your hands may be injured due to clinching.

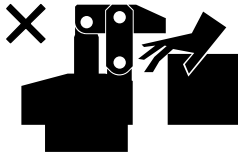

- 4) Do not disassemble or modify.
  - If the equipment is taken apart or modified, the warranty will be voided even within the warranty period.
- 5) Do not cover the top surface of the sensing area with metal objects (chips, sludge, etc.).
  - It may obstruct radio wave transmission. The cover is made of plastic material and should be protected from chips.

### ● Maintenance and Inspection

- 1) Removal of the Machine and Shut-off of Pressure Source
  - Before the machine is removed, make sure that safety devices and preventive devices are in place. Shut off the pressure and power source, and make sure no pressure exists in the air and hydraulic circuits.
  - Make sure there is no abnormality in the bolts and respective parts before restarting.
- 2) Regularly clean the area around the piston rod.
  - If it is used when the surface is contaminated with dirt, it may lead to packing seal damage, malfunctioning and fluid leakage.

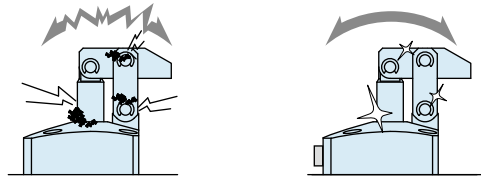

- 3) Regularly tighten pipe line, mounting bolt, nut, snap ring, cylinder and others to ensure proper use.
- 4) Make sure there is a smooth action without an irregular noise.
  - Especially when it is restarted after left unused for a long period, make sure it can be operated correctly.
- 5) The products should be stored in the cool and dark place without direct sunshine or moisture.
- 6) Please contact us for overhaul and repair.

## ● Warranty

### 1) Warranty Period

- The product warranty period is 18 months from shipment from our factory or 12 months from initial use, whichever is earlier.

### 2) Warranty Scope

- If the product is damaged or malfunctions during the warranty period due to faulty design, materials or workmanship, we will replace or repair the defective part at our expense.

Defects or failures caused by the following are not covered.

- ① If the stipulated maintenance and inspection are not carried out.
- ② If the product is used while it is not suitable for use based on the operator's judgment, resulting in defect.
- ③ If it is used or operated in an inappropriate way by the operator. (Including damage caused by the misconduct of the third party.)
- ④ If the defect is caused by reasons other than our responsibility.
- ⑤ If repair or modifications are carried out by anyone other than Kosmek, or without our approval and confirmation, it will void warranty.
- ⑥ Other caused by natural disasters or calamities not attributable to our company.
- ⑦ Parts or replacement expenses due to parts consumption and deterioration. (Such as rubber, plastic, seal material and some electric components.)

Damages excluding from direct result of a product defect shall be excluded from the warranty.

Please refer to the separate catalog for the receiver and repeater.

## Receiver



Model YWA

## Repeater



Model YWB

## Other Accessory

### Manifold Block

Model WHZ-MD



Kosmek Website  
<https://www.kosmek.com/>



## KOSMEK LTD.

► <https://www.kosmek.com/>

HEAD OFFICE 1-5, 2-chome, Murotani, Nishi-ku, Kobe-city, Hyogo, Japan 651-2241  
TEL.+81-78-991-5162 FAX.+81-78-991-8787

United States of America SUBSIDIARY	KOSMEK (USA) LTD. 650 Springer Drive, Lombard, IL 60148 USA TEL. +1-630-620-7650 FAX. +1-630-620-9015
MEXICO BRANCH OFFICE	KOSMEK USA MEXICO BRANCH OFFICE Av. Loma Pinal de Amoles 320-piso PH oficina 504 interior 13, Vista Dorada, 76060 Santiago de Querétaro, Qro. Mexico TEL. +52-442-851-1377
EUROPE SUBSIDIARY	KOSMEK EUROPE GmbH Schleppeplatz 2 9020 Klagenfurt am Wörthersee Austria TEL. +43-463-287587 FAX. +43-463-287587-20
CHINA SUBSIDIARY	KOSMEK (CHINA) LTD. Room601, RIVERSIDE PYRAMID No.55, Lane21, Pusan Rd, Pudong Shanghai 200125, China TEL. +86-21-54253000
INDIA BRANCH	KOSMEK LTD. - INDIA 4A/Old No:649, Ground Floor, 4th D cross, MM Layout, Kavalbyrasandra, RT Nagar, Bangalore -560032 India TEL.+91-9880561695
THAILAND REPRESENTATIVE OFFICE	KOSMEK Thailand Representation Office No.139, Blue Chips Building, 4th Floor, Room No.422, Soi Sukhumvit 63 (Thong Lor 10), Sukhumvit Road, Khlong Tan Nuea, Wattana, Bangkok 10110, Thailand TEL. +66(0)2-059-2010



WAHLTEC GmbH  
T: +49 (7584) 9238883  
F: +49 (7584) 9238887  
kosmek@wahltec.de  
www.wahltec.de

- For Further Information on Unlisted Specifications and Sizes, Please call us.
- Specifications in this Leaflet are Subject to Change without Notice.

