

New

Wireless Sensing High-Power Pneumatic Swing Clamp / Link Clamp

Air Lock / Air Release



High-Power Pneumatic Swing Clamp

model **WHP**



High-Power Pneumatic Link Clamp

model **WCP**

Wirelessly Detect Unclamp Position

No External Power Supply

Required for Sensor

AIR LOCK / AIR RELEASE

NEW

Wireless Sensing High-Power Pneumatic Clamp PAT.P.



High-Power Pneumatic Swing Clamp
model **WHP**



High-Power Pneumatic Link Clamp
model **WCP**

Wirelessly Detect Unclamp Position

No External Power Supply Required for Sensor

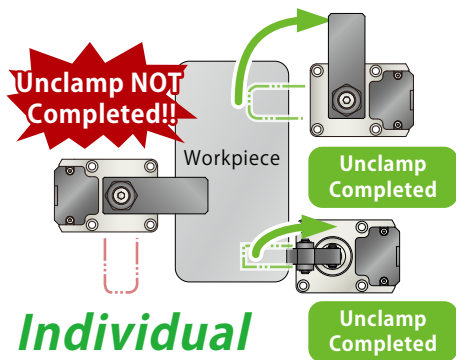

Individual Detection

Separate unclamp detection is possible for each clamp.



Waterproof Rating

Equivalent to **IPX7**

※ Shows the protection level of the sensor.



Quick Response[※]

※ Compared with our conventional air sensing clamps.

Minimized Number of Ports

Solution to fixture port shortage.

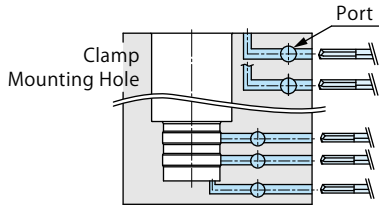

With
Wireless
Sensing

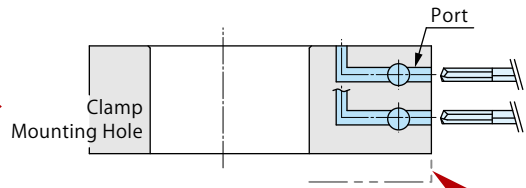

Conventional Fixture※ : Multiple Ports

Air Port × 2, Air Sensor Port × 2, Vent Port × 1

※Using our conventional air sensing clamp (model WHE-M)

Air sensor port is not required.

Air Port × 2

Enables a thinner
and lighter fixture.

Lower Design • Fixture Cost

Design & machining costs for sensing ports are not required.

※ Image compared with our conventional air sensing clamps.



With
Wireless
Sensing



Conventional※ sensing function needed design and machining costs for ports.

※ For conventional models, please see the "Changes in Sensing Clamps" .

Fixture is simplified.

Zero Air Consumption

Detect unclamp position via wireless communication.

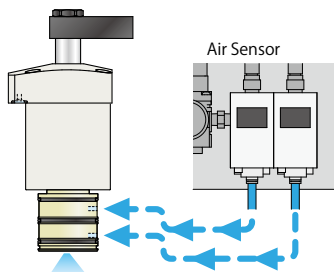

With
Wireless
Sensing

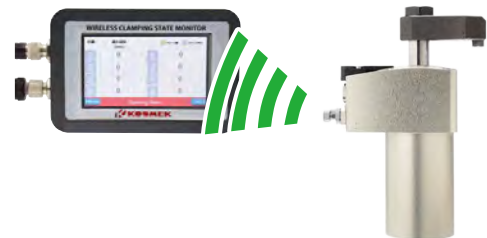

Consumes air for detection.

※Using our conventional air sensing clamp

Detects wirelessly, zero air consumption.

Changes in Sensing Clamps

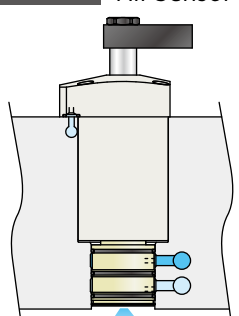
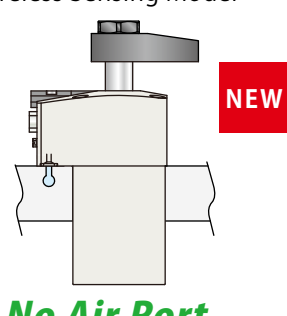
	Conventional Air Sensor Model	Wireless Sensing Model
Model		
Air Consumption	High	Zero
Cylinder Length	Long (High Interference)	Short

Please contact us when considering the wireless sensing clamp.

Wireless Sensing High-Power Pneumatic Link Clamp

Model WCP



Wirelessly Detect Unclamp Position.

Powerful clamping force and holding force replacing hydraulics.

Number of Ports is Reduced. No External Power Supply Required for Sensor

PAT.P.

- Detects unclamp position wirelessly.

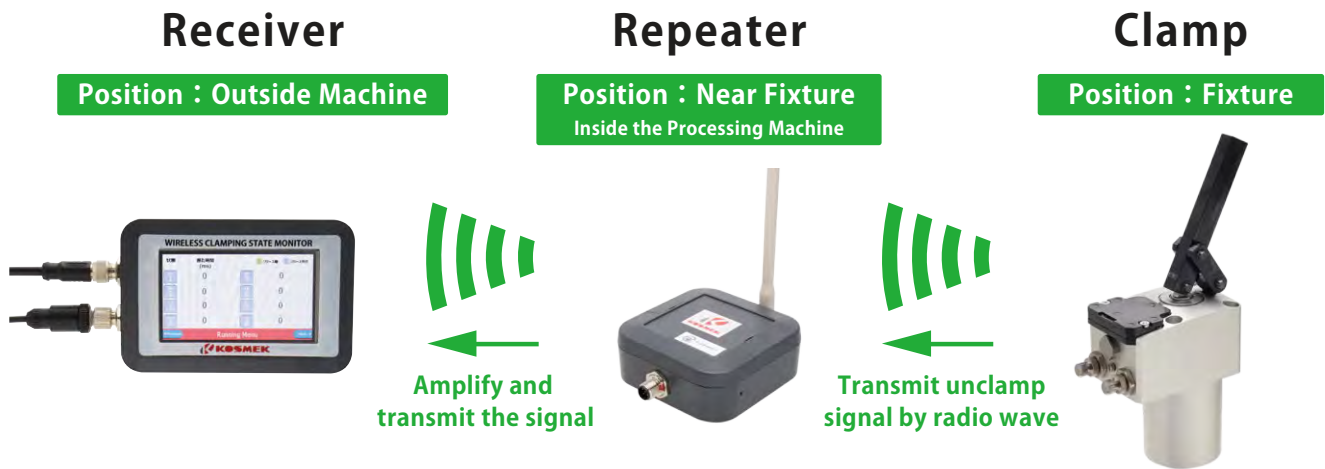

- Holding Force

Powerful holding force that exceeds clamping force allows minimizing the clamping force to the necessary minimum, thereby reducing workpiece distortion.

Holding force is 3 times the clamping force by a mechanical lock.^{※1}

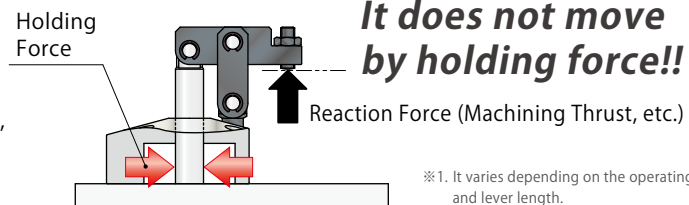

※1. It varies depending on the operating pressure and lever length.

Action Description

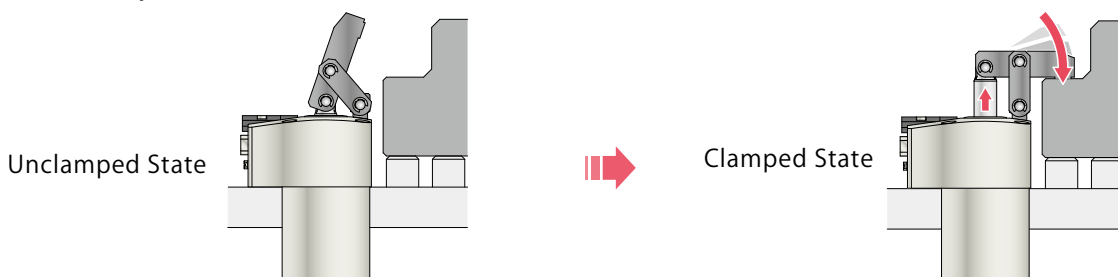

● Cross Section ※ This drawing shows Model WCP-2□□-B□.

Powerful Clamping Force and Holding Force

With mechanical lock, it exerts 2.5 times higher clamping force than the same size air cylinder, and powerful holding force to withstand large reaction force.

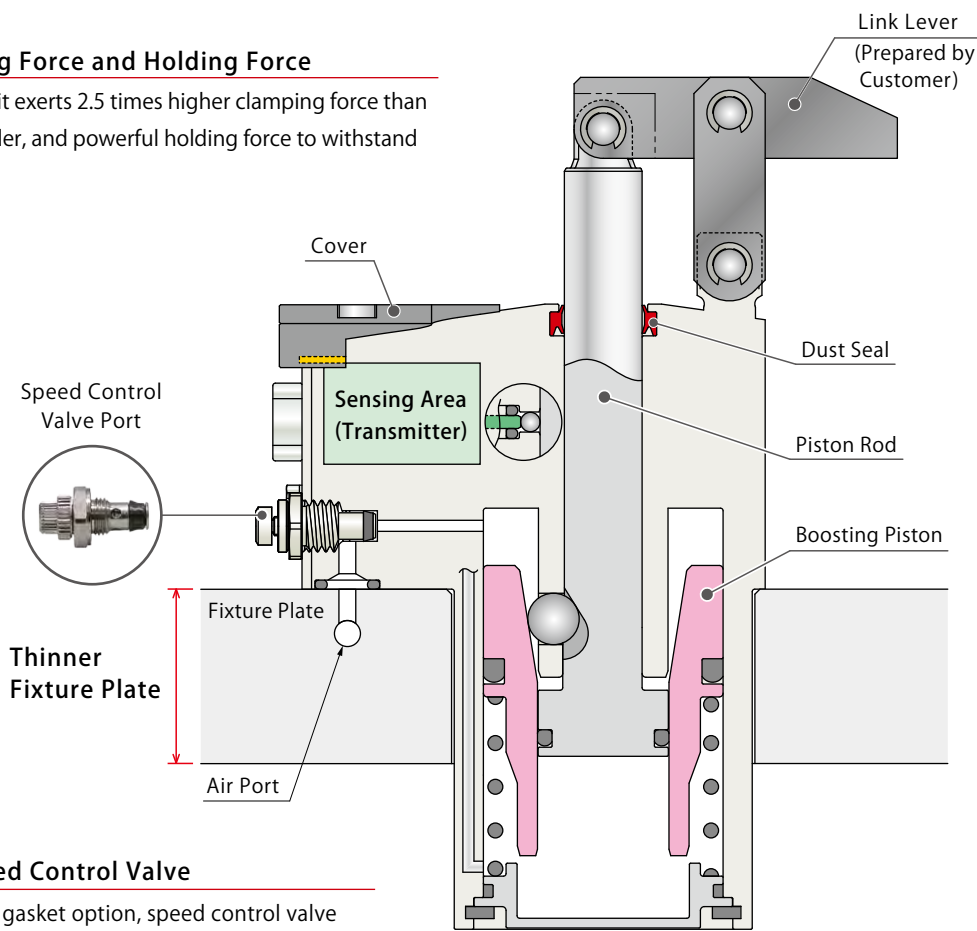

Direct Mount Speed Control Valve

For piping method A : gasket option, speed control valve can be directly mounted to the product. (Speed control valve is sold separately.)

Excellent Coolant Resistance

Our exclusive dust seal is designed to protect against high pressure coolant. It also has high durability against chlorine-based coolant by using a sealing material with excellent chemical resistance.

Lever in Three Directions Available

Lever positioning is available in three directions;
 L : Left, C : Center, R : Right as seen from the port side.

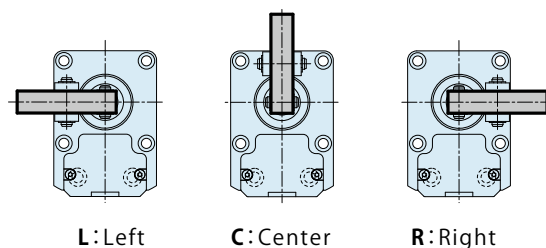

Zero Air Consumption

Detects unclamp position via wireless communication. Unlike our conventional air sensing clamps, air for action confirmation is not required.

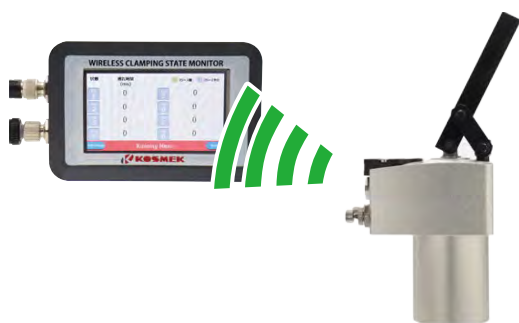

Minimized Number of Ports • Simple Machining

Integrating ports allows for reducing the number of ports for Rotary Joint and machining for air passage of fixture plate, and simplifying the machining of mounting hole, etc.

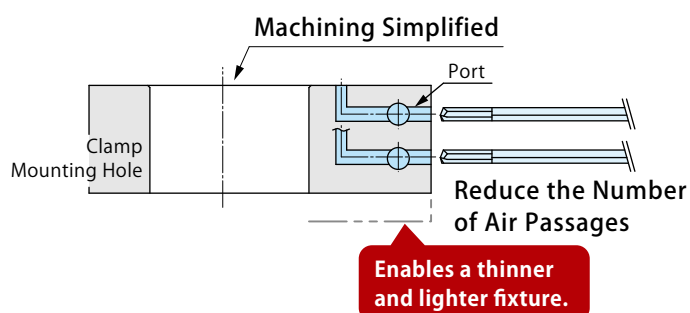
Wireless Sensing Clamp

Accessory

Common Cautions

Wireless Sensing High-Power Pneumatic Swing Clamp

WHP

Wireless Sensing High-Power Pneumatic Link Clamp

WCP

● Action Description (Internal Structure) ※ The figure shows Model WCP-2□□-B□.

Unclamp

Receiver ※Refer to the website and catalog (model YWA) for further information.

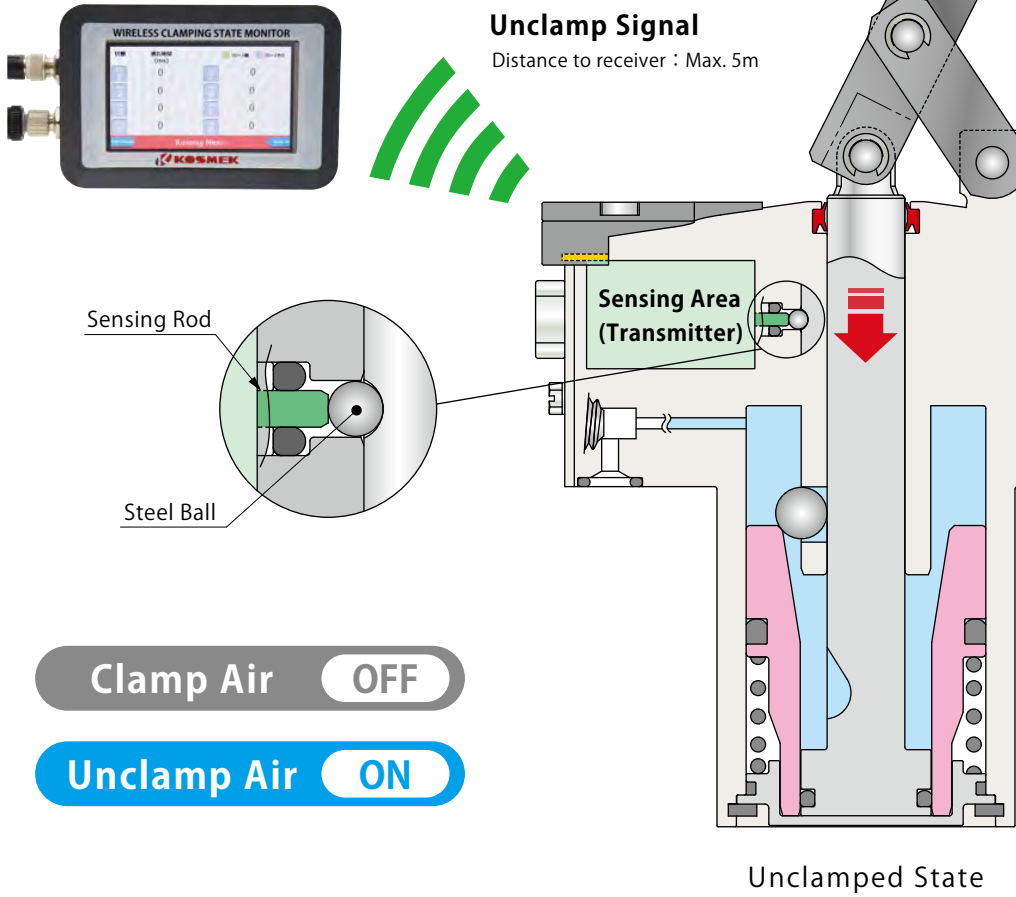

■ Unclamp (During Air Pressure Supply to Unclamping Port)

The piston rod descends.



When the piston rod pushes the sensing rod via the steel ball before the end of the unclamp stroke, an unclamp signal is transmitted from the sensing area.

Connecting Multiple Wireless Sensing Clamps

When using multiple wireless sensing clamps, provide an unclamp operating time difference of 100msec (0.1 sec.) or more. Please check the operating time at the receiver, and adjust the operating time with the speed control valve if it is within 100msec. Otherwise, signals cannot be received properly due to radio interference.

Clamp

Wireless Sensing Clamp

Accessory

Common Cautions

Wireless Sensing High-Power Pneumatic Swing Clamp

WHP

Wireless Sensing High-Power Pneumatic Link Clamp

WCP

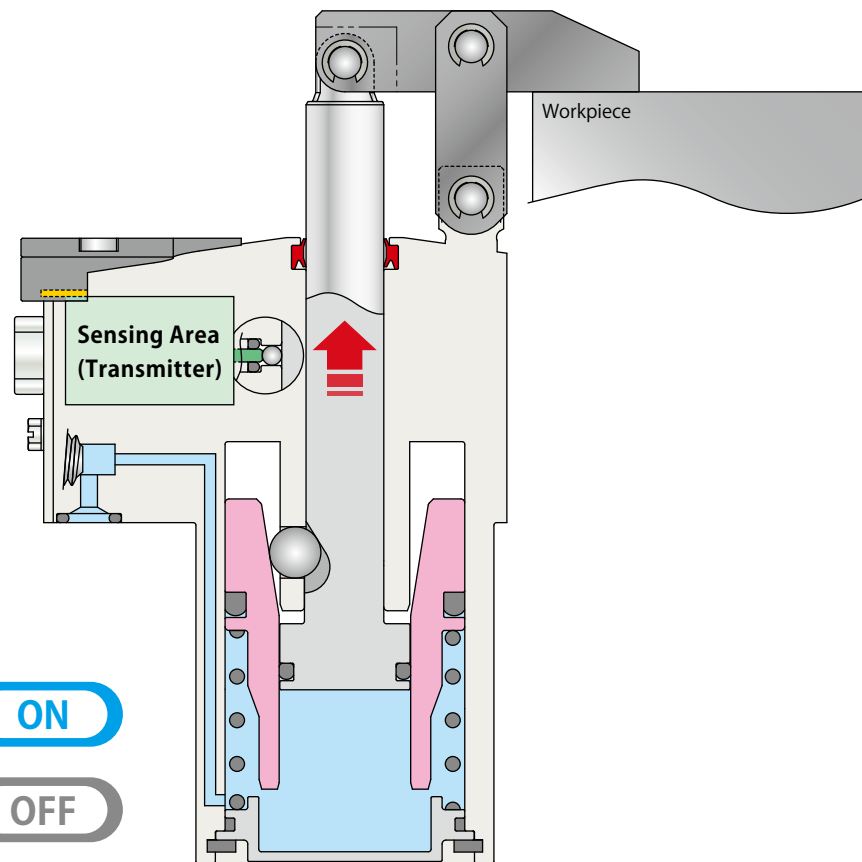

Clamped State

■ Clamp (During Air Pressure Supply to Clamping Port)

The piston rod ascends to clamp the workpiece. At the same time, the boosting piston operates, and powerful clamping and holding forces are generated by the wedge mechanism. ※ Make sure to clamp a workpiece within the clamp stroke range.

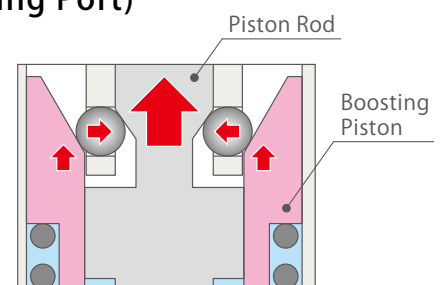

Self-Locking State

 Clamp Air **OFF**

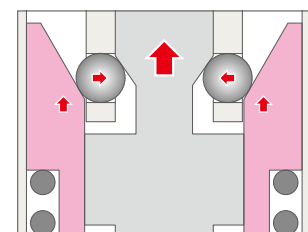
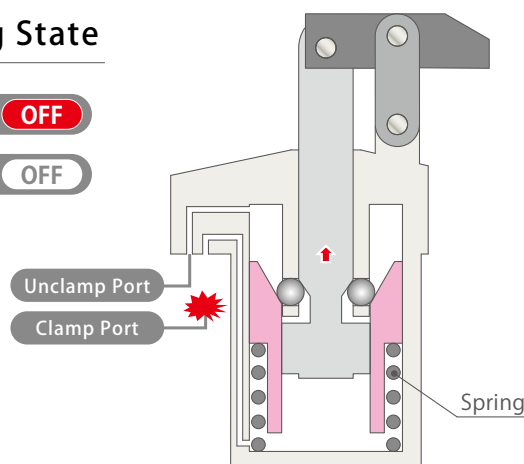
 Unclamp Air **OFF**

Self-Locking State

(Holding with Spring Force + Mechanical Lock)

If clamp air pressure drops to zero in the clamped state, the internal spring and mechanical lock maintains the clamped state.

● Model No. Indication

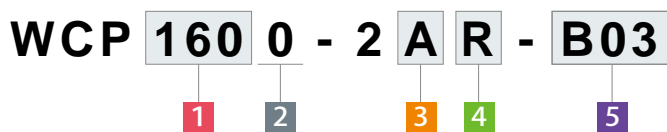

1 Cylinder Force

- 100** : Cylinder Force 0.9 kN (Air Pressure 0.5MPa)
- 160** : Cylinder Force 1.6 kN (Air Pressure 0.5MPa)
- 250** : Cylinder Force 2.4 kN (Air Pressure 0.5MPa)
- 400** : Cylinder Force 3.9 kN (Air Pressure 0.5MPa)

※ Cylinder force differs from clamping force and holding force.

2 Design No.

0 : Revision Number

3 Piping Method

- A** : Gasket Option (with Ports for Speed Controller)
- G** : Gasket Option (with R Thread Plug)
- S** : Piping Option (Rc Thread)

※ Speed control valve (BZW-A) is sold separately.
 Please use meter-in speed control valve for WCP.
In case of using Kosmek model, select BZW□-A.
 Please refer to P. 35.

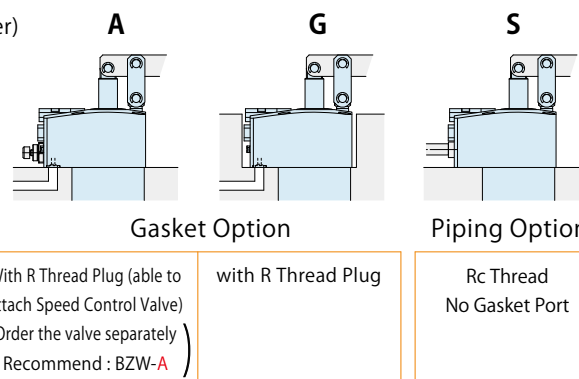

4 Lever Direction

- L** : Left
- C** : Center
- R** : Right

※ The images show the lever direction when the piping port is placed in front of you.

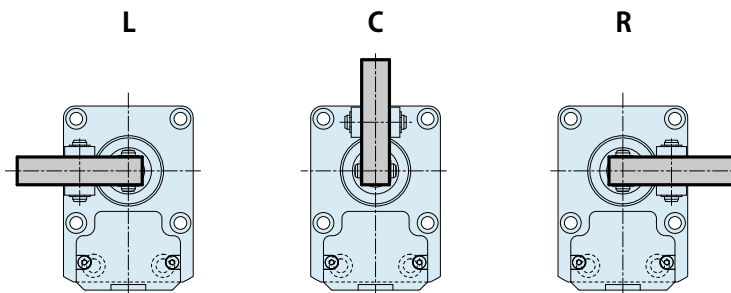

5 Available Country : Frequency

※ There are restrictions on countries where the product can be used according to radio regulations. Please follow the regulatory requirements of each country.

- B01** : Japan
- B02** : Europe, China
- B03** : United States

Specifications

Model No.		WCP1000-2□□-B□	WCP1600-2□□-B□	WCP2500-2□□-B□	WCP4000-2□□-B□	
Cylinder Force (at 0.5MPa)	kN	0.9	1.6	2.5	3.9	
Clamping Force		Refer to "Clamping Force Curve" on P.25				
Holding Force		Refer to "Holding Force Curve" on P.26				
Clamping Force and Holding Force at 0MPa		Refer to "Clamping Force and Holding Force Curve at 0 MPa" on P.27				
Full Stroke	mm	22	23.5	27.5	33	
(Break down)	Idle Stroke	mm	18	19.5	23.5	29
	Clamp Stroke ※1	mm	4	4	4	4
Cylinder	Clamp	22.4	35.8	56.1	95.6	
Capacity cm ³	Unclamp	19.9	32.1	50.6	85.2	
Spring Force	N	60.8 ~ 78.4	83.5 ~ 140.9	146.5 ~ 218.8	234.1 ~ 334.6	
Max. Operating Pressure	MPa	0.5				
Min. Operating Pressure ※2	MPa	0.25	0.2			
Withstanding Pressure	MPa	0.75				
Operating Temperature	°C	0 ~ 70 (Sensing Area: ~ 60°C)				
Usable Fluid		Dry Air				
Wireless Sensing (Unclamp Confirmation)	Frequency	5 When selecting B01 : 920MHz Band				
		5 When selecting B02 : 868MHz Band				
		5 When selecting B03 : 902MHz Band				
	Distance to Receiver	Max. 5m ※3				
Sensing Position	ON from 3mm before the unclamp end stroke.					
Waterproof Rating	Equal to IPX7 (When the cover of the sensing area is completely closed.)					

Notes :

- ※1. The specification value of cylinder force, clamping force and holding force is fulfilled only when clamping within the clamp stroke range. (The specification value is not fulfilled when clamping within the range of idle stroke.)
 - ※2. Minimum pressure to operate the clamp without load.
 - ※3. The maximum distance when there is no obstruction. Check the radio wave strength displayed on the receiver and consider the installation of the repeater. (Recommended Threshold Value:-85dBm)
1. Please refer to the external dimensions for product weight.

Wireless Sensing Clamp

Accessory

Common Cautions

Wireless Sensing High-Power Pneumatic Swing Clamp
WHP

Wireless Sensing High-Power Pneumatic Link Clamp

WCP

Clamping Force Curve

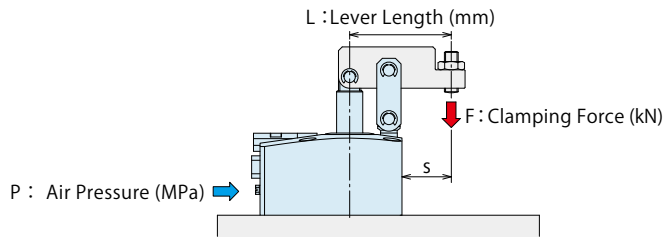

(How to read the clamping force curve)

In case of WCP2500 : When supply air pressure P is 0.3MPa and lever length L is 50mm, clamping force becomes about 1.46kN

Notes:

- ※ 1. F : Clamping Force (kN) , P : Supply Air Pressure (MPa) , L : Lever Length (mm)
- 1. Tables and graphs show the relationship between the clamping force (kN) and supply air pressure (MPa).
- 2. Cylinder force (when L=0) cannot be calculated from the formula of clamping force.
- 3. Values in below charts indicate clamping force when the lever locks a workpiece in horizontal position.
- 4. The clamping force varies depending on the lever length. Set the suitable supply air pressure based on the lever length.
- 5. Clamping force in the non-usable range may cause damage and fluid leakage.

WCP1000		Clamping Force Calculation Formula※1 (kN) $F = \frac{28.6 \times P + 2.2}{L - 19.5}$							
Air Pressure (MPa)	Cylinder Force (kN)	Clamping Force (kN)						Non-Usable Range (■)	Min. Lever Length (mm)
		Lever Length L (mm)							
		30	35	39	45	50	60		
0.5	0.94	■	■	0.85	0.65	0.54	0.41	39	
0.4	0.78	■	0.88	0.70	0.54	0.45	0.34	33	
0.3	0.62	1.03	0.70	0.55	0.42	0.35	0.27	29	
Max. Operating Pressure (MPa)		0.33	0.43	0.50	0.50	0.50	0.50		

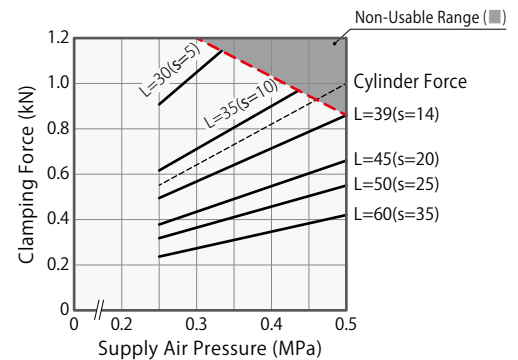

WCP1600		Clamping Force Calculation Formula※1 (kN) $F = \frac{51.6 \times P + 4.3}{L - 21}$							
Air Pressure (MPa)	Cylinder Force (kN)	Clamping Force (kN)						Non-Usable Range (■)	Min. Lever Length (mm)
		Lever Length L (mm)							
		33	35	42	50	60	70		
0.5	1.59	■	■	1.43	1.04	0.77	0.61	42	
0.4	1.32	■	■	1.19	0.86	0.64	0.51	36	
0.3	1.05	1.65	1.41	0.94	0.68	0.51	0.40	31	
0.2	0.77	1.22	1.04	0.70	0.50	0.37	0.30	28	
Max. Operating Pressure (MPa)		0.35	0.39	0.50	0.50	0.50	0.50		

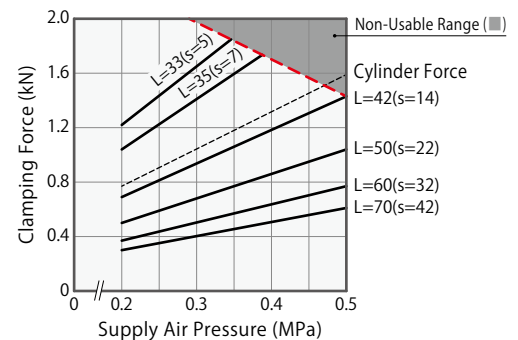

WCP2500		Clamping Force Calculation Formula※1 (kN) $F = \frac{93.9 \times P + 8.3}{L - 25}$							
Air Pressure (MPa)	Cylinder Force (kN)	Clamping Force (kN)						Non-Usable Range (■)	Min. Lever Length (mm)
		Lever Length L (mm)							
		38	45	50	60	70	80		
0.5	2.46	■	■	2.21	1.58	1.23	1.00	50	
0.4	2.04	■	2.29	1.83	1.31	1.02	0.83	42	
0.3	1.62	2.81	1.82	1.46	1.04	0.81	0.66	37	
0.2	1.20	2.08	1.35	1.08	0.77	0.60	0.49	33	
Max. Operating Pressure (MPa)		0.32	0.43	0.50	0.50	0.50	0.50		

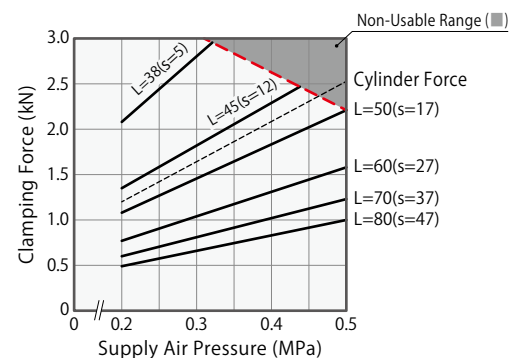

WCP4000		Clamping Force Calculation Formula※1 (kN) $F = \frac{179.2 \times P + 16.1}{L - 30}$							
Air Pressure (MPa)	Cylinder Force (kN)	Clamping Force (kN)						Non-Usable Range (■)	Min. Lever Length (mm)
		Lever Length L (mm)							
		45	50	60	70	80	90		
0.5	3.92	■	■	3.52	2.64	2.11	1.76	60	
0.4	3.25	■	■	2.93	2.19	1.76	1.46	51	
0.3	2.59	4.66	3.49	2.33	1.75	1.40	1.16	44	
0.2	1.92	3.46	2.60	1.73	1.30	1.04	0.87	39	
Max. Operating Pressure (MPa)		0.31	0.39	0.50	0.50	0.50	0.50		

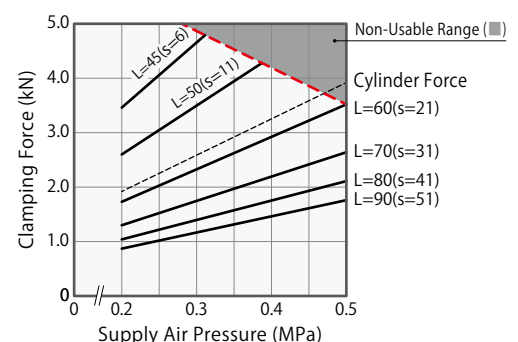

● Holding Force Curve

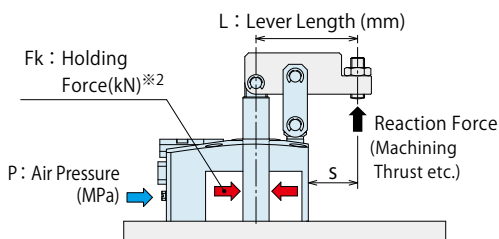

(Ex.1) In case of WCP1600 :

When supply air pressure P is 0.2MPa and lever length L is 50mm, holding force becomes about 1.79kN.

(Ex.2) In case of WCP1600 : When supply air pressure P is 0.5MPa and lever length L is 50mm, the calculated value is at the point A but it is in the non-usable range. In this case, the value of intersection B becomes the holding force that counters the reaction force, and it is about 2.58kN.

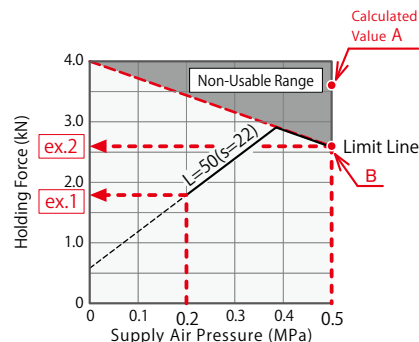

Notes: ※2. Holding force is the force that counters the reaction force in the clamping state, and differs from clamping force.

Please keep in mind that it can produce displacement depending on lever rigidity even if the reaction force is lower than holding force. (If slight displacement is also not allowed, please keep the reaction force beyond clamping force from being applied.)

※3. Fk : Holding Force (kN) , P : Supply Air Pressure (MPa) , L : Lever Length (mm).

When the calculated holding force exceeds the value of a limit line, the holding force becomes the value of a limit line.

1. Tables and graphs show the relationship between the holding force (kN) and supply air pressure (MPa).
2. Values in below charts indicate holding force when the lever locks a workpiece in horizontal position.
3. The holding force varies depending on the lever length. Set the suitable supply air pressure based on the lever length.
4. The reaction force exceeding the holding force shown in the table and the graph may cause damage and fluid leakage.

WCP1000		Holding Force Formula ※3 (kN) $F_k = \frac{97.6 \times P + 10.0}{L - 19.5}$		(Fk ≤ Limit Line Value) (kN)			
Supply Air Pressure (MPa)	Lever Length L (mm)						Non-Usable Range Limit Line Value (kN)
	30	35	39	45	50	60	
0.5			1.67	1.67	1.67	1.45	1.67
0.4		1.84	1.84	1.84	1.61	1.21	1.84
0.3	2.01	2.01	2.01	1.54	1.29	0.97	2.01

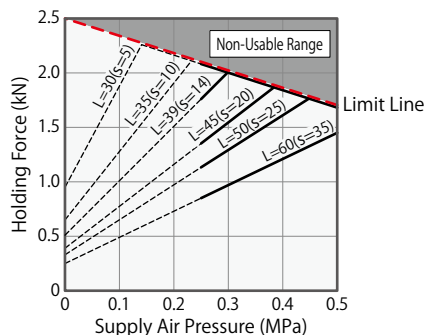

WCP1600		Holding Force Formula ※3 (kN) $F_k = \frac{175.2 \times P + 16.8}{L - 21}$		(Fk ≤ Limit Line Value) (kN)			
Supply Air Pressure (MPa)	Lever Length L (mm)						Non-Usable Range Limit Line Value (kN)
	33	35	42	50	60	70	
0.5			2.58	2.58	2.58	2.13	2.58
0.4			2.86	2.86	2.23	1.77	2.86
0.3	3.14	3.14	3.14	2.39	1.78	1.42	3.14
0.2	3.42	3.42	2.47	1.79	1.33	1.06	3.42

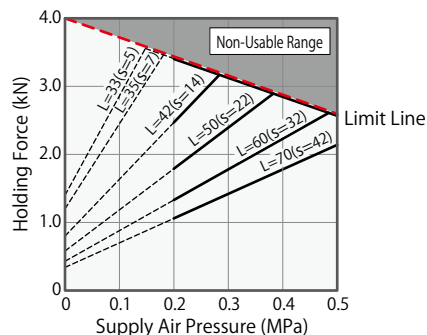

WCP2500		Holding Force Formula ※3 (kN) $F_k = \frac{325.6 \times P + 32.6}{L - 25}$		(Fk ≤ Limit Line Value) (kN)			
Supply Air Pressure (MPa)	Lever Length L (mm)						Non-Usable Range Limit Line Value (kN)
	38	45	50	60	70	80	
0.5			3.81	3.81	3.81	3.55	3.81
0.4		4.24	4.24	4.24	3.62	2.96	4.24
0.3	4.67	4.67	4.67	3.72	2.90	2.37	4.67
0.2	5.10	4.89	3.91	2.79	2.17	1.78	5.10

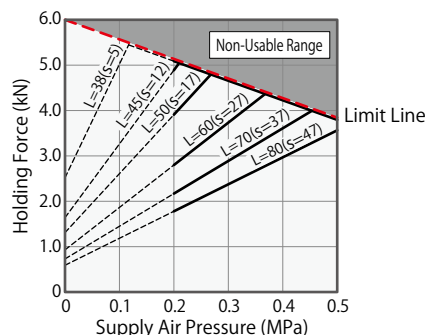

WCP4000		Holding Force Formula ※3 (kN) $F_k = \frac{673.9 \times P + 68}{L - 30}$		(Fk ≤ Limit Line Value) (kN)			
Supply Air Pressure (MPa)	Lever Length L (mm)						Non-Usable Range Limit Line Value (kN)
	45	50	60	70	80	90	
0.5			5.48	5.48	5.48	5.48	5.48
0.4			6.16	6.16	6.16	5.63	6.16
0.3	6.85	6.85	6.85	6.75	5.40	4.50	6.85
0.2	7.53	7.53	6.76	5.07	4.06	3.38	7.53

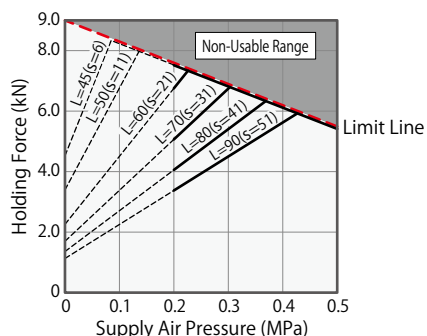

Wireless Sensing Clamp

Accessory

Common Cautions

Wireless Sensing High-Power Pneumatic Swing Clamp

WHP

Wireless Sensing High-Power Pneumatic Link Clamp

WCP

Clamping Force and Holding Force Curve at 0MPa

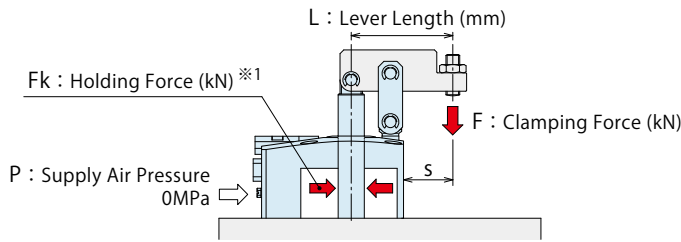

(How to read the clamping force and holding force curve at 0MPa air pressure)

In case of WCP1600

When air supply is shut off at clamped state:

Supply Air Pressure = 0MPa

Lever Length L= 50 mm

Clamping force becomes about 0.15 kN.

Holding force becomes about 0.58 kN.

Notes:

※1. Holding force shows the force which can counter to the reaction force in the clamping state, and differ from clamping force.

Moreover, keep in mind that it may produce displacement depending on lever rigidity even if it is the reaction force below holding force.

(When slight displacement is also not allowed, please keep the reaction force beyond clamping force from being applied.)

※2. F : Clamping force (kN) , Fk : Holding force (kN) , L : Lever length (mm).

1. The tables and the graphs show the relationship between lever length (mm) and the clamping force (kN) and holding force (kN) at the time of 0MPa.
2. The clamping force and holding force at the time of zero air pressure show capability when a lever locks in a level position.
3. Clamping force and holding force vary depending on lever length.

WCP1000						
Clamping Force Formula at 0MPa Air Pressure ※2 (kN)			$F = \frac{2.2}{L - 19.5}$			
Holding Force Formula at 0MPa Air Pressure ※2 (kN)			$Fk = \frac{10.0}{L - 19.5}$			
Lever Length (mm)	30	35	39	45	50	60
Clamping Force Reference Value at 0MPa (kN)	0.21	0.14	0.11	0.09	0.07	0.05
Holding Force Reference Value at 0MPa (kN)	0.95	0.65	0.51	0.39	0.33	0.25

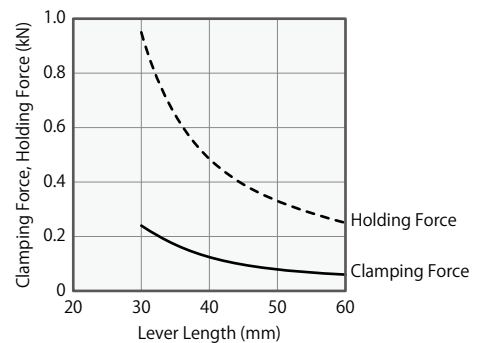

WCP1600						
Clamping Force Formula at 0MPa Air Pressure ※2 (kN)			$F = \frac{4.3}{L - 21}$			
Holding Force Formula at 0MPa Air Pressure ※2 (kN)			$Fk = \frac{16.8}{L - 21}$			
Lever Length (mm)	33	35	42	50	60	70
Clamping Force Reference Value at 0MPa (kN)	0.36	0.31	0.20	0.15	0.11	0.09
Holding Force Reference Value at 0MPa (kN)	1.40	1.20	0.80	0.58	0.43	0.34

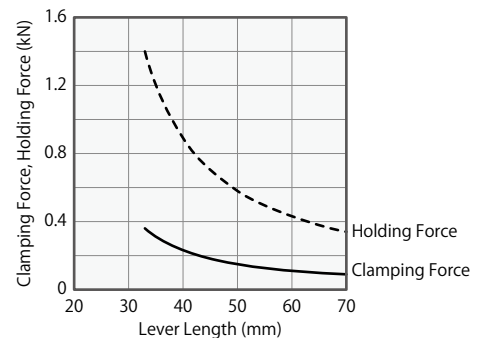

WCP2500						
Clamping Force Formula at 0MPa Air Pressure ※2 (kN)			$F = \frac{8.3}{L - 25}$			
Holding Force Formula at 0MPa Air Pressure ※2 (kN)			$Fk = \frac{32.6}{L - 25}$			
Lever Length (mm)	38	45	50	60	70	80
Clamping Force Reference Value at 0MPa (kN)	0.64	0.42	0.33	0.24	0.18	0.15
Holding Force Reference Value at 0MPa (kN)	2.51	1.63	1.30	0.93	0.72	0.59

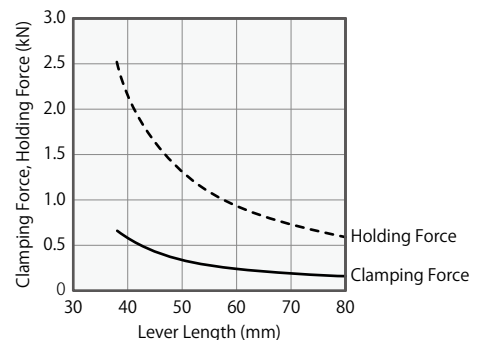

WCP4000						
Clamping Force Formula at 0MPa Air Pressure ※2 (kN)			$F = \frac{16.1}{L - 30}$			
Holding Force Formula at 0MPa Air Pressure ※2 (kN)			$Fk = \frac{68.0}{L - 30}$			
Lever Length (mm)	45	50	60	70	80	90
Clamping Force Reference Value at 0MPa (kN)	1.07	0.80	0.54	0.40	0.32	0.27
Holding Force Reference Value at 0MPa (kN)	4.53	3.40	2.27	1.70	1.36	1.13

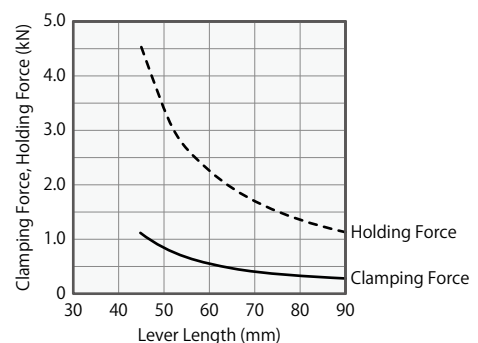

Allowable Offset Graph

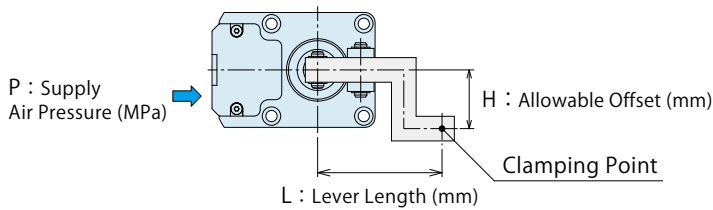

(Ex.)

In case of WCP2500 :

When supply air pressure P is 0.3MPa and lever length L is 50mm, allowable offset becomes about 18mm.

Notes :

1. Tables and graphs show the relationship between the lever length and the allowable offset according to the supply air pressure.
2. Using the lever beyond allowable offset may cause deformation, seizure and fluid leakage etc.
3. The tables and graphs are only for reference. The design should be carried out with allowance fully taken into consideration.

WCP1000

Supply Air Pressure (MPa)	Allowable Offset H (mm)						Non-Usable Range (■)
	L=30	L=35	L=39	L=45	L=50	L=60	
0.5	■	■	2	2	3	3	
0.4	■	5	6	7	7	9	
0.3	9	10	12	13	15	18	

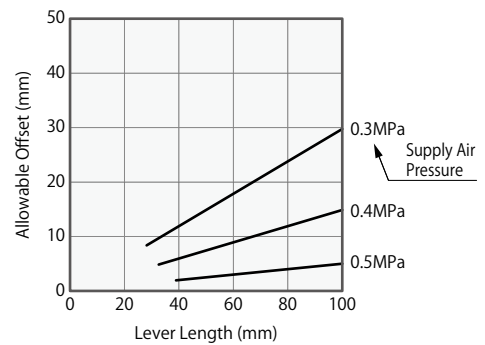

WCP1600

Supply Air Pressure (MPa)	Allowable Offset H (mm)						Non-Usable Range (■)
	L=33	L=35	L=42	L=50	L=60	L=70	
0.5	■	■	2	3	3	4	
0.4	■	■	7	8	9	11	
0.3	10	11	13	16	19	22	
0.2	16	17	20	24	28	33	

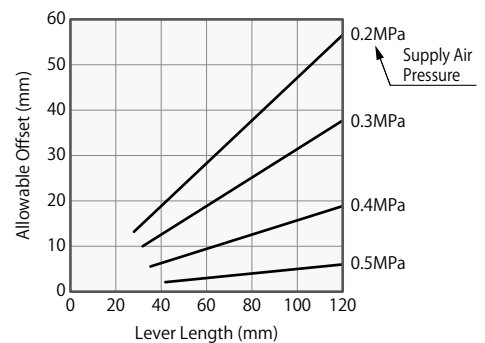

WCP2500

Supply Air Pressure (MPa)	Allowable Offset H (mm)						Non-Usable Range (■)
	L=38	L=45	L=50	L=60	L=70	L=80	
0.5	■	■	3	3	4	5	
0.4	■	8	9	11	12	14	
0.3	13	16	18	21	25	28	
0.2	20	24	26	32	37	42	

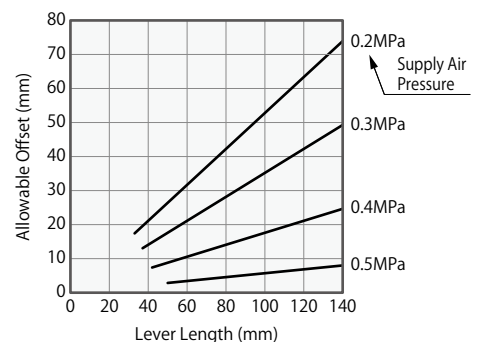

WCP4000

Supply Air Pressure (MPa)	Allowable Offset H (mm)						Non-Usable Range (■)
	L=45	L=50	L=60	L=70	L=80	L=90	
0.5	■	■	4	4	5	5	
0.4	■	■	11	13	15	17	
0.3	17	19	22	26	30	34	
0.2	25	28	34	39	45	50	

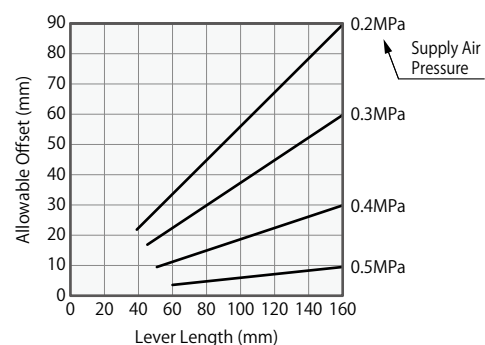
Wireless Sensing Clamp

Accessory

Common Cautions

 Wireless Sensing High-Power Pneumatic Swing Clamp
 WHP

Wireless Sensing High-Power Pneumatic Link Clamp

WCP

External Dimensions

A : Gasket Option

(With Ports for Speed Controller : R-Thread Plug Included)

※ The drawing shows the clamped state of WCP-2AC-B□.

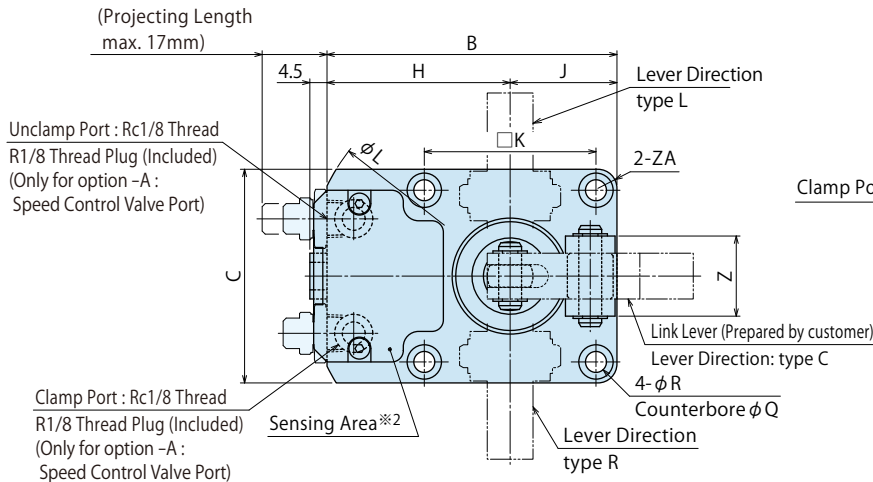

Machining Dimensions of Mounting Area

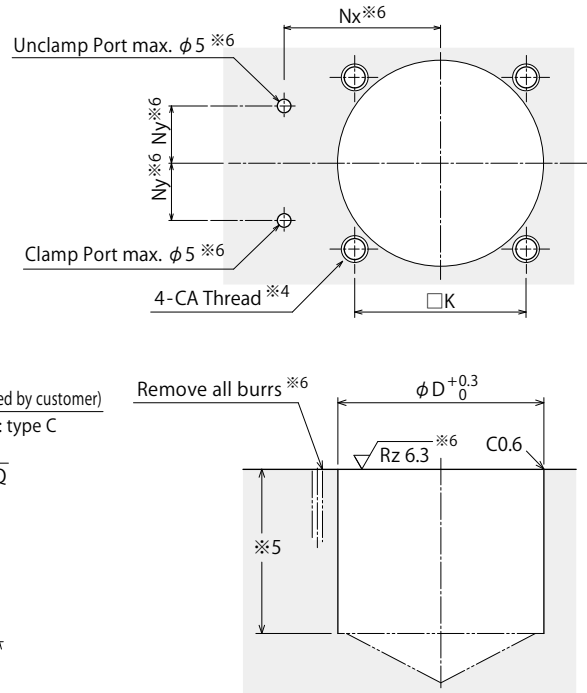

Notes :

- ※4. CA tapping depth of the mounting bolt should be decided according to the mounting height referring to dimension 'S'.
- ※5. The depth of the body mounting hole φ D should be decided according to the mounting height referring to dimension 'F'.
- ※6. The machining dimension is for -A/-G : Gasket Option.

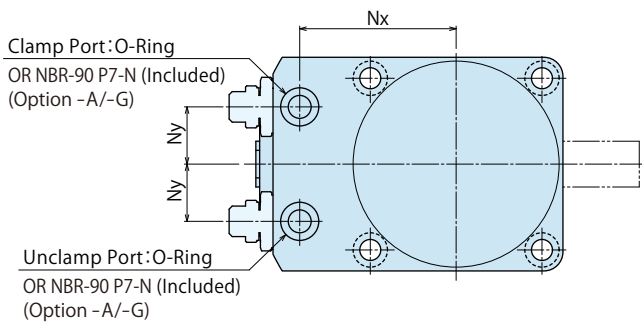
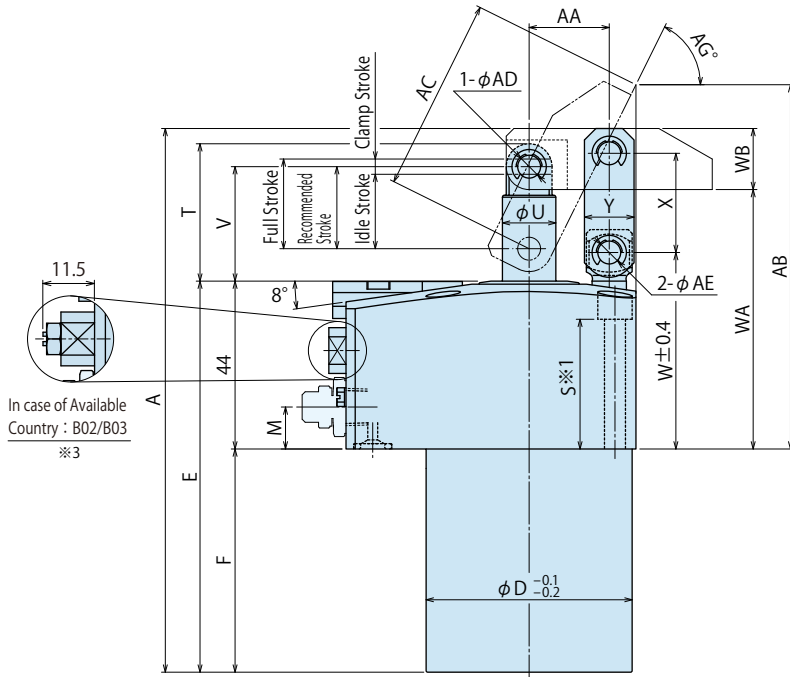

Piping Method

G : Gasket Option (With R Thread Plug)

※The drawing shows the clamped state of WCP-2GC.

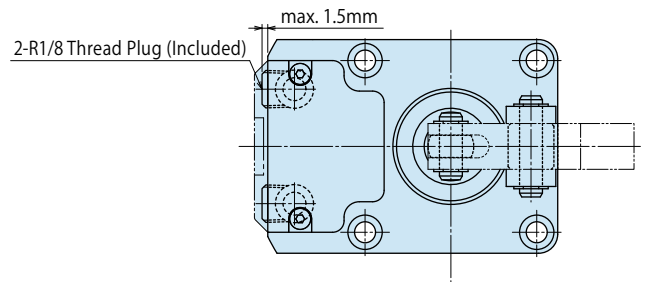

S : Piping Option (Rc Thread)

※The drawing shows the clamped state of WCP-2SC.

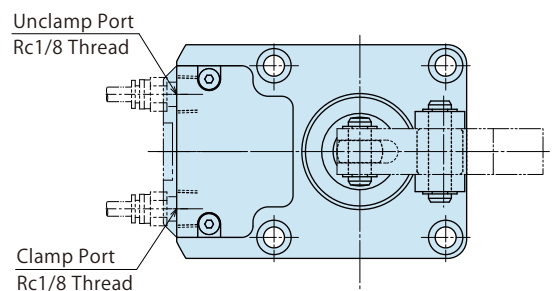

Notes :

- ※1. Mounting bolts are not provided. Please prepare them according to the mounting height referring to dimension 'S'.
- ※2. Do not cover the top surface of the sensing area with metal objects (chips, sludge, etc.). It may obstruct radio wave transmission.
- ※3. Please refer to P.33 "Notes for Design 2) Radio Regulations" .
 1. Please use the attached pin (equivalent to φ ADf6, φ AEf6, HRC60) as the mounting pin for lever.
 2. Speed control valve is sold separately. Please refer to P.35. It is necessary to provide an unclamp operation time difference of at least 100 msec. For adjusting the unclamp operation, please use a speed control valve.

Model No. Indication

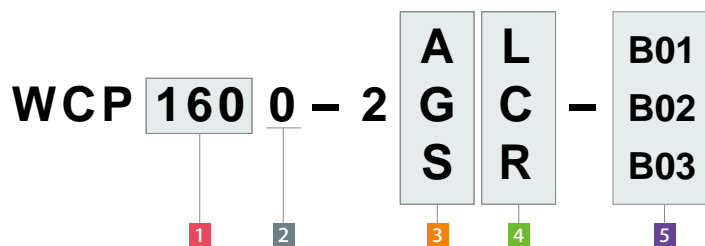

(Format Example : WCP1000-2AR-B02,
WCP2500-2SC-B03)

- 1 Cylinder Force
- 2 Design No.
- 3 Piping Method
- 4 Lever Direction
- 5 Available Country : Frequency

Wireless Sensing Clamp

Accessory

Common Cautions

Wireless Sensing High-Power Pneumatic Swing Clamp

WHP

Wireless Sensing High-Power Pneumatic Link Clamp

WCP

External Dimensions and Machining Dimensions for Mounting

(mm)

Model No.	WCP1000-2□□-B□	WCP1600-2□□-B□	WCP2500-2□□-B□	WCP4000-2□□-B□
Full Stroke	22	23.5	27.5	33
(Break down)	Idle Stroke	18	19.5	23.5
	Clamp Stroke ^{※7}	4	4	4
Recommended Stroke	20	21.5	25.5	31
A	131.5	142.5	165.5	193
B	71.5	76	83	92
C	50	56	66	78
D	46	54	64	77
E	96.5	102.5	117.5	133.5
F	52.5	58.5	73.5	89.5
H	46.5	48	50	53
J	25	28	33	39
K	39	45	53	65
L	103	107	112	122
M	10	11	11	11
Nx	39.5	41	43	46
Ny	14	15	16	20
Q	9	9	11	11
R	5.5	5.5	6.8	6.8
S	35	34	32	31
T	31.5	36	40	50.5
U	12	14	16	20
V	27	30	34	42.5
W	50	51.5	51.5	54.5
X	23.5	26	32.5	39.5
Y	11	13	16	18
Z	19	21	28	37
AA	19.5	21	25	30
AB	91	95.5	106.2	119.7
AC	46.9	50.9	62.7	74.7
AD	5	6	6	8
AE	5	6	8	10
AG [°]	63.5	63.6	63.9	64.8
CA (Nominal × Pitch)	M5×0.8	M5×0.8	M6×1	M6×1
WA	66.5	68	72	78.5
WB	12.5	16	20	25
ZA (Chamfer)	R5	R5	R6	R6
Weight ^{※8} kg	0.8	1.1	1.6	2.5

Notes :

※7. The specification value of cylinder force, clamping force, and holding force is fulfilled only when clamping within the clamp stroke range. (The specification value is not fulfilled when clamping within the range of idle stroke.)

※8. It shows the weight of single link clamp without the link lever.

Link Lever Design Dimensions

※ Reference for designing a link lever.

Corresponding Model No.

WCP 0 - 2

A	L	B01
G	C	B02
S	R	B03

1 Cylinder Force

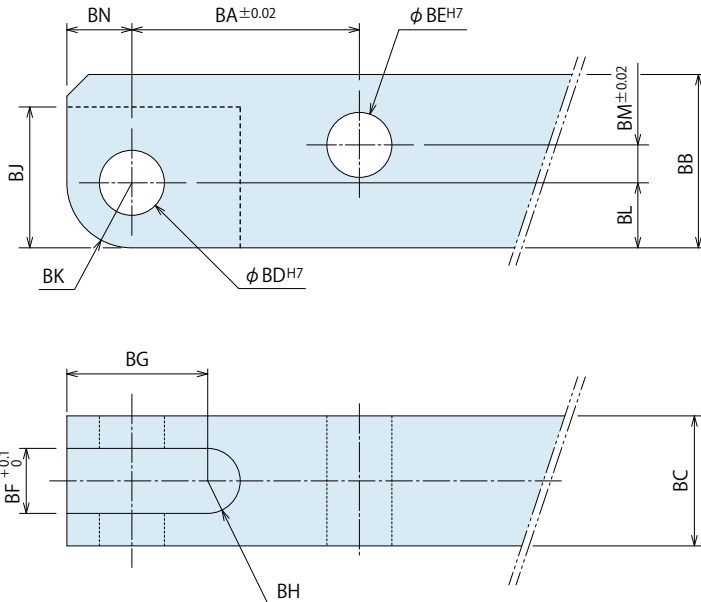

Calculation List of Link Lever Design Dimension

(mm)

Corresponding Model No.	WCP1000-2□□-B□	WCP1600-2□□-B□	WCP2500-2□□-B□	WCP4000-2□□-B□
BA	19.5	21	25	30
BB	12.5	16	20	25
BC	10 ⁰ / _{-0.2}	12 ⁰ / _{-0.3}	16 ⁰ / _{-0.3}	19 ⁰ / _{-0.3}
BD	5 ^{+0.012} / ₀	6 ^{+0.012} / ₀	6 ^{+0.012} / ₀	8 ^{+0.015} / ₀
BE	5 ^{+0.012} / ₀	6 ^{+0.012} / ₀	8 ^{+0.015} / ₀	10 ^{+0.015} / ₀
BF	5	6	8	10
BG	10	13	13	17
BH	R2.5	R3	R4	R5
BJ	10	13	13	17.5
BK	R4.5	R6	R6	R8
BL	4.5	6	6	8
BM	2.5	3.5	6	7.5
BN	4.5	6	6	8

Notes :

- 1.Link lever should be designed with its length according to performance curve.
- 2.If the link lever is not in accordance with the dimension shown above, performance may be degraded and damage can occur.
- 3.Please use the attached pin (equivalent to φADf6, φAEf6, HRC60) as the lever mounting pin.
(Refer to external dimensions of the clamp body for the dimensions of φAD, φAE.)

Accessory : Material Link Lever

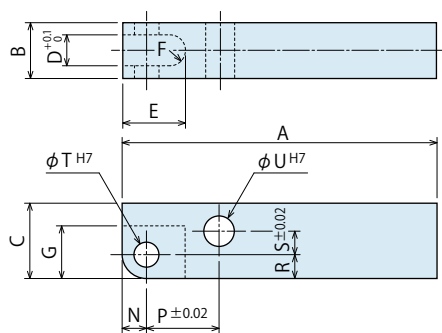

Model No. Indication

WCZ 160 0 - L2

Size (Refer to the table.) Design No. (Revision Number)

(mm)

Model No.	WCZ1000-L2	WCZ1600-L2	WCZ2500-L2	WCZ4000-L2
Corresponding Model No.	WCP1000	WCP1600	WCP2500	WCP4000
A	90	100	115	140
B	10 _{-0.2} ⁰	12 _{-0.3} ⁰	16 _{-0.3} ⁰	19 _{-0.3} ⁰
C	12.5	16	20	25
D	5	6	8	10
E	12.5	16	17	22
F	R2.5	R3	R4	R5
G	10	13	13	17.5
N	4.5	6	6	8
P	19.5	21	25	30
R	4.5	6	6	8
S	2.5	3.5	6	7.5
T	5 ₀ ^{+0.012}	6 ₀ ^{+0.012}	6 ₀ ^{+0.012}	8 ₀ ^{+0.015}
U	5 ₀ ^{+0.012}	6 ₀ ^{+0.012}	8 ₀ ^{+0.015}	10 ₀ ^{+0.015}

Notes :

1. Material : S45C Surface Finishing : Alkaline Blackening
2. If necessary, the front end should be additionally machined and finished.
3. Please use the attached pin (equivalent to ϕ ADf6, ϕ Aef6, HRC60) as the lever mounting pin.

**Wireless
Sensing Clamp**

Accessory

Common
CautionsWireless Sensing
High-Power
Pneumatic
Swing Clamp

WHP

Wireless Sensing
High-Power
Pneumatic
Link Clamp

WCP

Cautions

Notes for Design

- 1) Check Specifications
 - Please use each product according to the specifications.
- 2) Radio Regulations
 - There are restrictions on countries where the product can be used according to radio regulations. Please follow the regulatory requirements of each country. (Ex.) WCP □ - 2□□ - B03 can be used in United States.

Regarding WCP □ - 2□□ - B02/B03

- At shipment, the signal transmission is in a disabled state, with the function stop nut attached. When enabling signal transmission, please remove the "function stop nut" before use.

Signal Transmission Function OFF Setting

- If it is absolutely necessary to operate this product in a country other than the available country, please disable the signal transmission function using the following settings.
By attaching the "function stop nut" and fixing the sensing rod to prevent movement, the signal transmission function can be stopped.

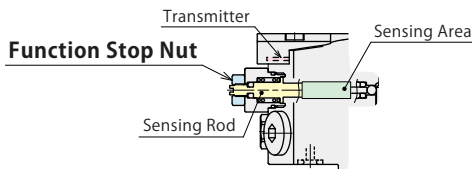

※ 5 Available Country : B01 does not support this function. (Please contact us separately if necessary.)

Notes for Circuit Design

- Ensure there is no possibility of supplying air pressure to the clamp port and the unclamp port simultaneously. Improper circuit design may lead to malfunctions and damages.

Notes for Link Lever Design

- Make sure no force is applied to the piston rod except from the axial direction. The usage like the one shown in the drawing below will apply a large bending stress to the piston rod and must be avoided.

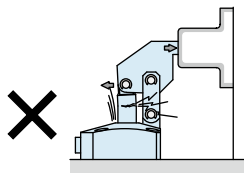

- If offset load is applied on the link part, use it within the allowable range of "Allowable Offset Graph".
- 5) Protect the exposed area of the piston rod when using on a welding fixture.
 - If spatter attaches to the sliding surface it could lead to malfunction and fluid leakage.
- 6) When clamping on a sloped surface of the workpiece
 - Make sure the clamping surface and the mounting surface of the clamp are parallel.

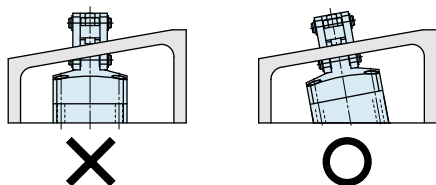

- 7) When using in a dry environment
 - The link pin can be dried out. Grease it periodically or use a special pin. Contact us for the specifications of special pins.
- 8) Speed Adjustment
 - If the clamp operates too fast, the parts will be worn out and become damaged more quickly leading to equipment failure. Do not adjust with a meter-out valve outside the cylinder because there is an orifice of meter-out connected internally. (The operating time of mechanical locking mechanism will be very long if there is back pressure in the circuit.) Install a meter-in speed controller and adjust the operating time to within 0.5 seconds. If the operating time is slower than this, pressure rising will slow down taking more time to achieve the clamping force corresponding to the catalog data. Even if there is stiff or sudden movement under low pressure and small volume of air, it is not a malfunction. (Please note that the above condition will occur when you have to adjust operating time over 1.0 second.)

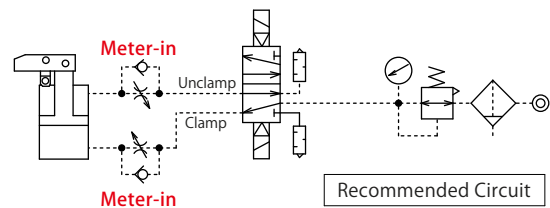

Please set one speed controller (meter-in) to each clamp when operating multiple clamps simultaneously. When large thrust force is applied to the unclamping direction in unclamping action, install a meter-out speed controller to the clamp port side for speed adjustment.

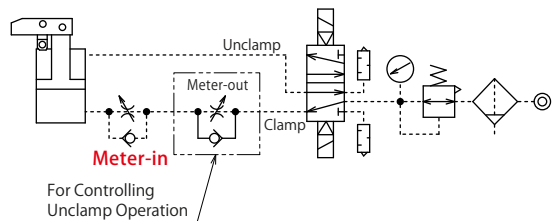

- For adjusting the unclamp operating time, please use a speed control valve.
- 9) The specification value will not be fulfilled when clamping out of the clamp stroke (mechanical lock stroke) range.
 - When the center of link pin hole of piston rod clamps out of the clamp stroke range, the mechanical lock function does not work. As a result, the specification value of clamping force and holding force will not be fulfilled. Moreover, there will be no clamping or holding force at 0MPa air pressure.

Make sure the actual stroke to be ± 2 mm of recommended clamping position. (The specification value will be fulfilled since the center of link pin hole of piston rod is within the clamp stroke (mechanical lock stroke) range.

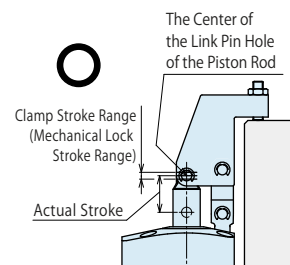

● Notes for Usage

- 1) Do not cover the top surface of the sensing area with metal objects (chips, sludge, etc.). It may obstruct radio wave transmission. The cover is made of plastic material and should be protected from chips.

● Installation Notes

- 1) Check the Usable Fluid

- Please provide filtered clean dry air. (Install a drain removing device.)
- Oil supply with a lubricator, etc. is not necessary. Oil supply with a lubricator may cause loss of the initial lubricant, and the operation under low pressure/speed may be unstable. (When using secondary lubricant, please supply lubricant continuously. Otherwise, the initial grease applied from KOSMEK will be removed from the secondary lubricant.)

- 2) Installation of the Product

- When mounting the clamp, use four hexagonal socket bolts (with tensile strength of 12.9) and tighten them with the torque shown in the table below. Tightening with greater torque than recommended can dent the seating surface or break the bolt.

Model No.	Mounting Bolt Size	Tightening Torque (N·m)
WCP1000	M5×0.8	6.3
WCP1600	M5×0.8	6.3
WCP2500	M6×1	10
WCP4000	M6×1	10

- 3) Installation of the Speed Control Valve

- Tightening torque for installing speed control valve is 5 to 7 N·m.

- 4) Installation / Removal of the Link Lever

- When inserting a link pin, do not hit the pin directly with a hammer. When using a hammer to insert the pin, always use a cover plate with a smaller diameter than the spring ring groove on the pin.

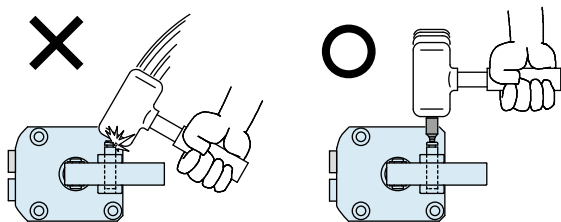

- 5) Speed Adjustment

- Adjust the speed so that the operating time is within 0.5 sec. If the clamp operates too fast the parts will be worn out leading to premature damage and ultimately complete equipment failure.
- Turn the speed control valve gradually from the low-speed side (small flow) to the high-speed side (large flow) to adjust the speed.
- When using multiple wireless sensing clamps, provide an unclamping time difference of 100msec (0.1 sec.) or more. Simultaneous operation may cause radio interference, which may result in failure to receive unclamp signals properly. For adjusting the unclamp operation, please use a speed control valve.

- 6) Checking Looseness and Retightening

- At the beginning of the machine installation, bolts may be tightened lightly. Check looseness and re-tighten as required.

- 7) Initial Connection Settings for the Receiver

During setup, it is necessary to perform the initial connection settings between the clamp and the receiver. (For detailed instructions, refer to the instruction manual of receiver YWA.)

- 8) Cautions for Repeater Installation

The maximum distance between the clamp and the receiver is 5 meters. Check the radio wave strength displayed on the receiver and consider the installation of the repeater. (Recommended Threshold : -85dBm)
It is recommended to install the repeater in locations such as the upper part inside the processing machine, where it is less likely to be exposed to coolant or chips.

Guidelines for Repeater Installation

- ① When the receiver cannot be installed at a height of 2 meters or more.
- ② When there is a radio wave obstruction between the clamp and the receiver.
- ③ When the clamp and the receiver are more than 3 meters apart.

- 9) Do Not Operate the Clamp Manually

- At the time of not supplying air pressure, when a piston rod is raised by manual operation and it goes into the clamp stroke range, the mechanical lock will be activated by built-in spring and the clamp will be locked (the piston rod at the clamp end). Clamping force at 0MPa will be generated as well. Since this will cause an injury and accident, never operate the clamp manually.

In order to avoid such accidents, the product is set in the clamped state (with mechanical lock activated) before shipping. It is recommended to set the clamp in clamped state (with mechanical lock activated) when shipping to a user after installing the clamp to a fixture or system.

In the clamped state, clamps cannot be operated manually because of the mechanical lock. Supplying unclamp air pressure is required to conduct unclamp action.

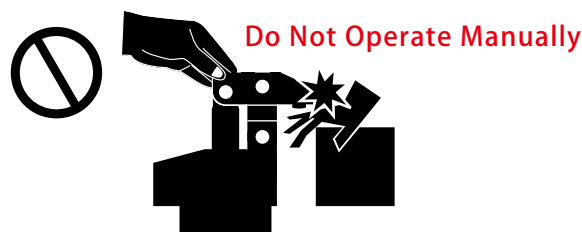

Air Flow Control Valve

Model BZW



Directly mounted to clamps, easy adjusting

- **Directly Mounted to Clamps**

BZW is the flow control valve for Rc thread that enable to mount to the piping method : option -A of WHP/WCP. It is best used in a circuit where the flow control valve cannot be mounted or if necessary to synchronize individual speed.

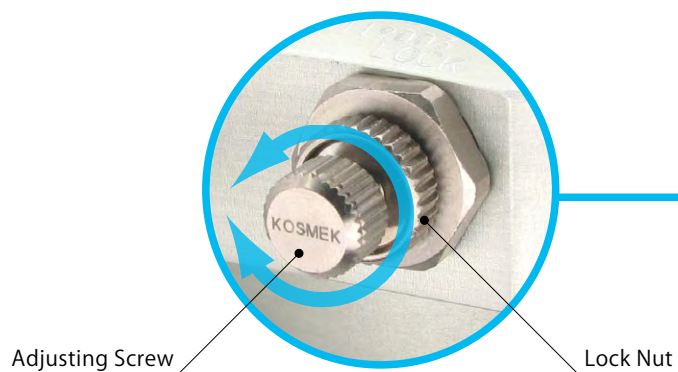

Corresponding Product Model

Clamps	BZW Model No.	Clamp Model No.
Wireless Sensing High-Power Pneumatic Link Clamp	BZW0100- A	WCP □ 0-2 A □
Wireless Sensing High-Power Pneumatic Swing Clamp	BZW0100- B	WHP □ 0-2 A □

Corresponding to piping method -A option.

※ When mounting BZW to the piping method G, take off R thread plug and remove the sealing tape not to get inside the cylinder.

Model No. Indication

BZW 010 0 - B

Control Method
B : Meter-out
A : Meter-in

Design No.
0 : Revision Number

R Thread Size
010 : Rc1/8

Specifications

Model No.	BZW0100-B	BZW0100-A
Control Method	Meter-out	Meter-in
Operating Pressure MPa	0.1 ~ 1.0	
Withstanding Pressure MPa	1.5	
Adjusting Screw Number of Rotations	10	
Tightening Torque N·m	5 ~ 7	
Weight g	13	
Corresponding Model No.	WHP□-2A□-B□	WCP□-2A□-B□

Circuit Symbol

BZW0100-B : Meter-out

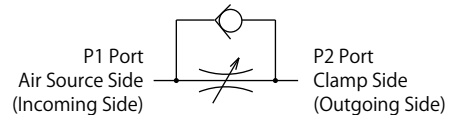

BZW0100-A : Meter-in

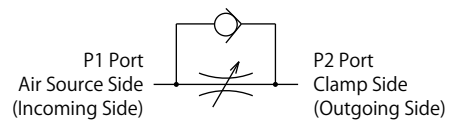

External Dimensions

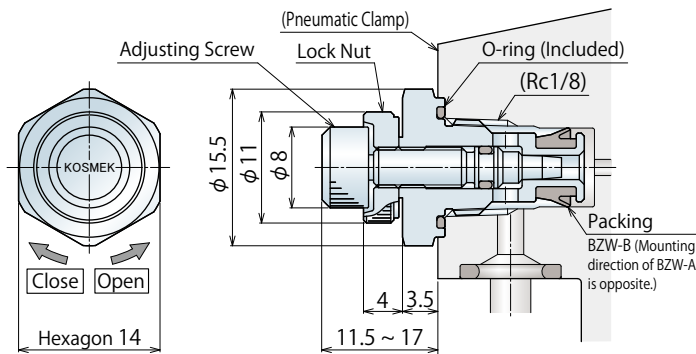

Flow Rate Graph

BZW0100-B/BZW0100-A common

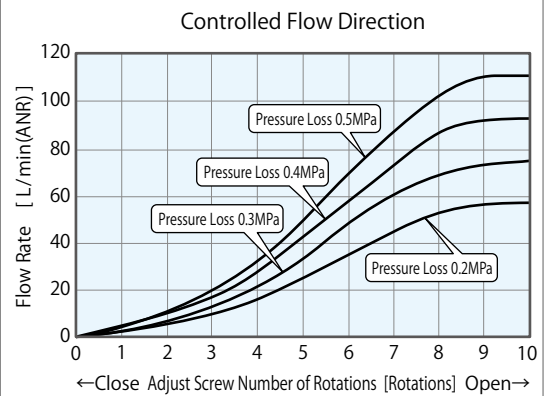

Machining Dimensions of Mounting Area

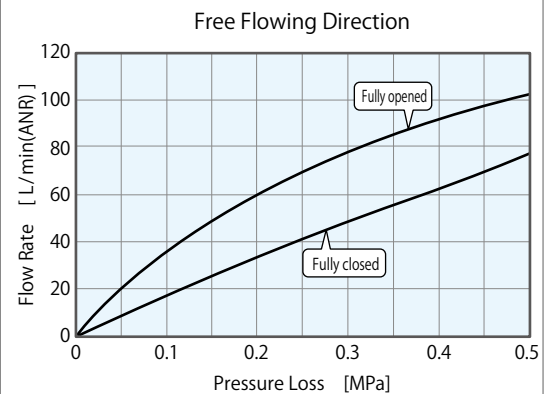
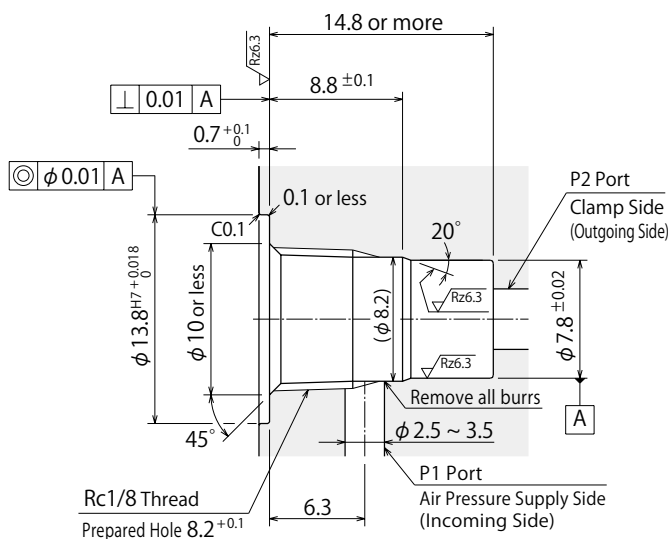

Notes :

1. Since the $\sqrt{R26.3}$ area is sealing part, be careful not to damage it.
2. No cutting chips or burr should be at the tolerance part of machining hole.
3. As shown in the drawing, P1 port is used as the air supply side and P2 port as the clamp side.

ⓘ Cautions

● Notes on Handling

- 1) It should be operated by qualified personnel.
 - Machines and devices with hydraulic and pneumatic products should be operated and maintained by qualified personnel.
- 2) Do not operate or remove the product unless the safety protocols are ensured.
 - ① Machines and devices can only be inspected or prepared when it is confirmed that the safety devices are in place.
 - ② Before the product is removed, make sure that the above-mentioned safety devices are in place. Shut off the pressure and power source, and make sure no pressure exists in the air and hydraulic circuits.
 - ③ After stopping the product, do not remove until the temperature drops.
 - ④ Make sure there is no trouble/issue in the bolts and respective parts before restarting a machine or device.
- 3) Do not touch a clamp (cylinder) while it is working. Otherwise, your hands may be injured due to clinching.

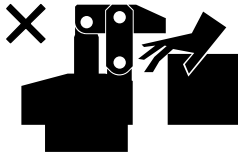

- 4) Do not disassemble or modify.
 - If the equipment is taken apart or modified, the warranty will be voided even within the warranty period.
- 5) Do not cover the top surface of the sensing area with metal objects (chips, sludge, etc.).
 - It may obstruct radio wave transmission. The cover is made of plastic material and should be protected from chips.

● Maintenance and Inspection

- 1) Removal of the Machine and Shut-off of Pressure Source
 - Before the machine is removed, make sure that safety devices and preventive devices are in place. Shut off the pressure and power source, and make sure no pressure exists in the air and hydraulic circuits.
 - Make sure there is no abnormality in the bolts and respective parts before restarting.
- 2) Regularly clean the area around the piston rod.
 - If it is used when the surface is contaminated with dirt, it may lead to packing seal damage, malfunctioning and fluid leakage.

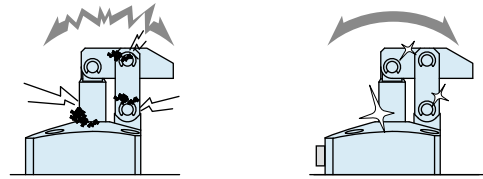

- 3) Regularly tighten pipe line, mounting bolt, nut, snap ring, cylinder and others to ensure proper use.
- 4) Make sure there is a smooth action without an irregular noise.
 - Especially when it is restarted after left unused for a long period, make sure it can be operated correctly.
- 5) The products should be stored in the cool and dark place without direct sunshine or moisture.
- 6) Please contact us for overhaul and repair.

● Warranty

1) Warranty Period

- The product warranty period is 18 months from shipment from our factory or 12 months from initial use, whichever is earlier.

2) Warranty Scope

- If the product is damaged or malfunctions during the warranty period due to faulty design, materials or workmanship, we will replace or repair the defective part at our expense. Defects or failures caused by the following are not covered.
 - ① If the stipulated maintenance and inspection are not carried out.
 - ② If the product is used while it is not suitable for use based on the operator's judgment, resulting in defect.
 - ③ If it is used or operated in an inappropriate way by the operator. (Including damage caused by the misconduct of the third party.)
 - ④ If the defect is caused by reasons other than our responsibility.
 - ⑤ If repair or modifications are carried out by anyone other than Kosmek, or without our approval and confirmation, it will void warranty.
 - ⑥ Other caused by natural disasters or calamities not attributable to our company.
 - ⑦ Parts or replacement expenses due to parts consumption and deterioration. (Such as rubber, plastic, seal material and some electric components.)

Damages excluding from direct result of a product defect shall be excluded from the warranty.

Please refer to the separate catalog for the receiver and repeater.

Receiver



Model YWA

Repeater



Model YWB

Other Accessory

Manifold Block

Model WHZ-MD



Kosmek Website
<https://www.kosmek.com/>



KOSMEK LTD.

► <https://www.kosmek.com/>

HEAD OFFICE 1-5, 2-chome, Murotani, Nishi-ku, Kobe-city, Hyogo, Japan 651-2241
 TEL.+81-78-991-5162 FAX.+81-78-991-8787

United States of America SUBSIDIARY	KOSMEK (USA) LTD. 650 Springer Drive, Lombard, IL 60148 USA TEL. +1-630-620-7650 FAX. +1-630-620-9015
MEXICO BRANCH OFFICE	KOSMEK USA MEXICO BRANCH OFFICE Av. Loma Pinal de Amoles 320-piso PH oficina 504 interior 13, Vista Dorada, 76060 Santiago de Querétaro, Qro. Mexico TEL. +52-442-851-1377
EUROPE SUBSIDIARY	KOSMEK EUROPE GmbH Schleppeplatz 2 9020 Klagenfurt am Wörthersee Austria TEL. +43-463-287587 FAX. +43-463-287587-20
CHINA SUBSIDIARY	KOSMEK (CHINA) LTD. Room601, RIVERSIDE PYRAMID No.55, Lane21, Pusan Rd, Pudong Shanghai 200125, China TEL. +86-21-54253000
INDIA BRANCH	KOSMEK LTD. - INDIA 4A/Old No:649, Ground Floor, 4th D cross, MM Layout, Kavalbyrasandra, RT Nagar, Bangalore -560032 India TEL.+91-9880561695
THAILAND REPRESENTATIVE OFFICE	KOSMEK Thailand Representation Office No.139, Blue Chips Building, 4th Floor, Room No.422, Soi Sukhumvit 63 (Thong Lor 10), Sukhumvit Road, Khlong Tan Nuea, Wattana, Bangkok 10110, Thailand TEL. +66(0)2-059-2010



WAHLTEC GmbH
 T: +49 (7584) 9238883
 F: +49 (7584) 9238887
 kosmek@wahltec.de
 www.wahltec.de

- For Further Information on Unlisted Specifications and Sizes, Please call us.
- Specifications in this Leaflet are Subject to Change without Notice.

