

**New**

# Linear Cylinder with Cushion

---



Model LLP

 **WAHLTEC**<sup>®</sup>  
KNOWLEDGE | TRUST | SUCCESS

 **KOSMEK**  
Harmony in Innovation

Hydraulic Double Acting

# Linear Cylinder with Cushion

Model LLP

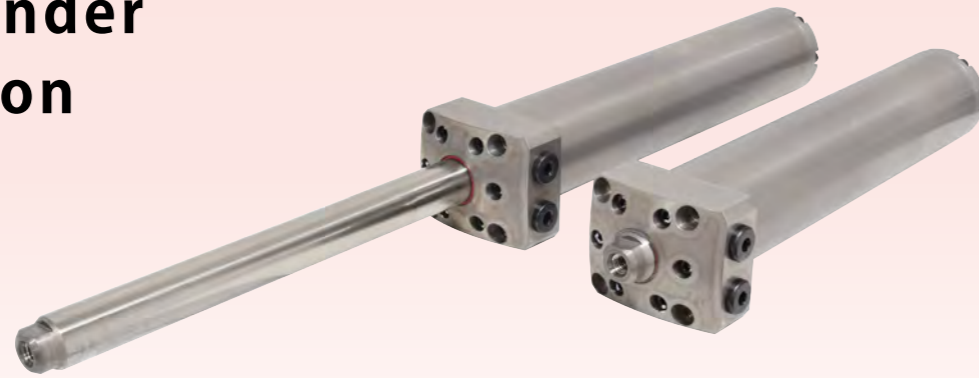

## Cushioning to slow speed just before the stroke ends

Higher speed in the middle of the stroke enables shorter cycle time.

Stroke selectable in 5mm increments.

Cushioning mechanism to control the speed near stroke ends, allows both cycle time reduction and longer operational life.

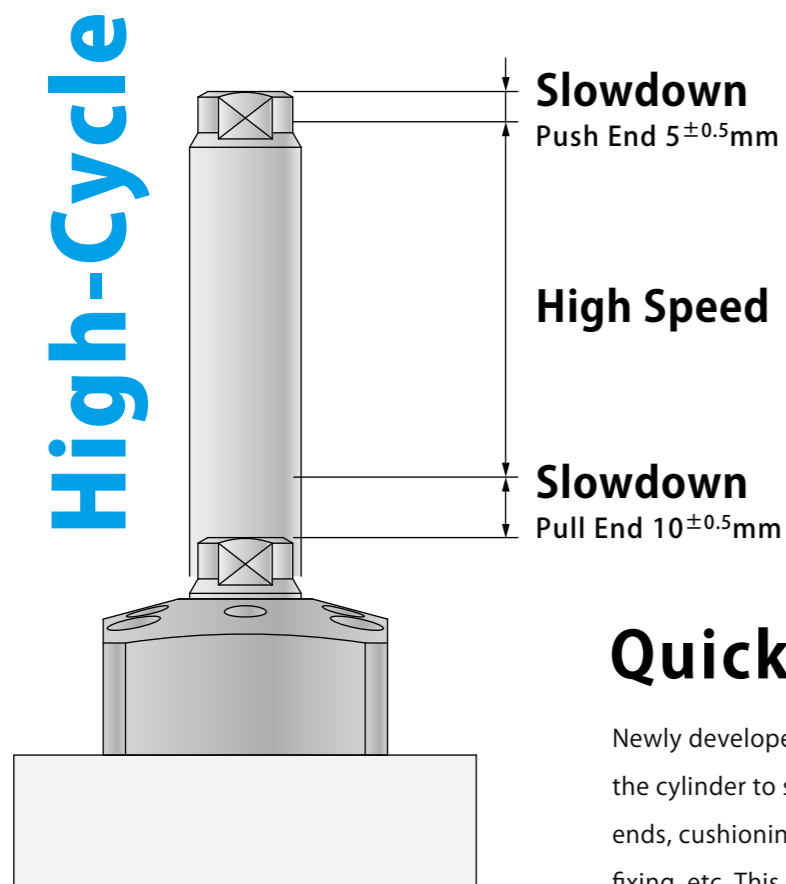

## Quick and Gentle

Newly developed cushioning mechanism enables the cylinder to slow its speed just before the stroke ends, cushioning the impact of transferring and fixing, etc. This also allows for higher speed than the current model LL in the middle of the stroke leading to shorter cycle time.

### Application Examples

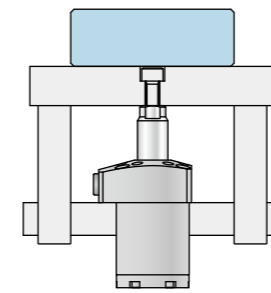

For Lifting

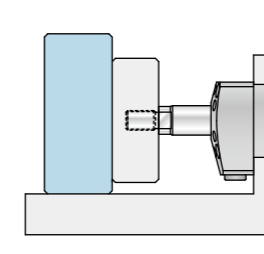

For Shifting

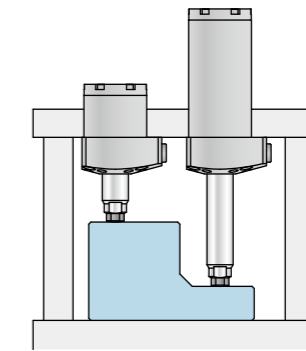

For Clamping, Press-Fit and Pressing

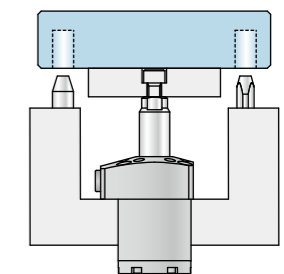

For Knocking In

### Features

#### Stroke in 5mm Increments

Stroke can be specified in 5mm increments within 50~200mm\*.  
\* 50~100mm only for LLP0400.

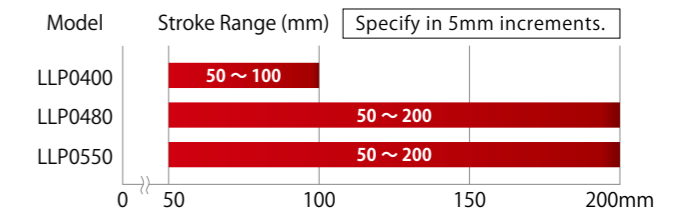

#### Excellent Coolant Resistance

Our exclusive dust seal is designed to protect against high pressure coolant. It also has high durability against chlorine-based coolant by using a sealing material with excellent chemical resistance.

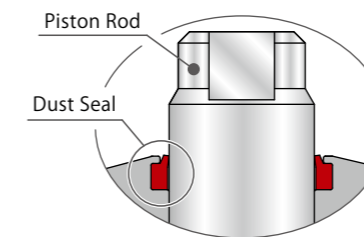

#### Direct Mount Speed Control Valve

Speed control valve with air bleeding function can be directly mounted to the product. (Speed control valve is sold separately.)



#### 3 Tip Shapes



#### Tip Shape Selectable from 3 Types

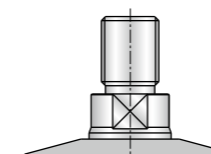
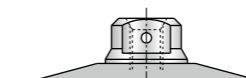
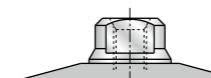

#### All Ports Set in Flange

There are two piping options. Gasket option needs no piping on the fixture. Piping option enables simple piping with all ports set in flange.

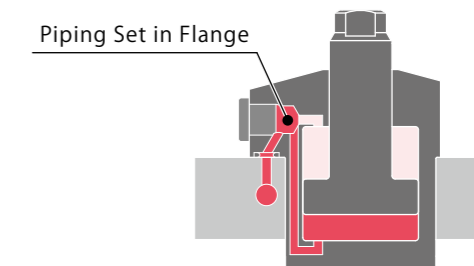

\* This drawing is an image.



Model No. Indication

**LLP 048 0 - C A B - 050**

1 2 3 4 5 6

1 Body Size

- 040 :  $\phi D=40\text{mm}$
- 048 :  $\phi D=48\text{mm}$
- 055 :  $\phi D=55\text{mm}$

※ Outer diameter ( $\phi D$ ) of the cylinder.

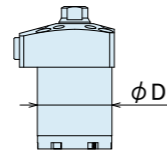

2 Design No.

- 0 : Revision Number

3 Piping Method

- C : Gasket Option (With G Thread Plug)
- S : Piping Option (Rc Thread)

※ Speed control valve (BZL) is sold separately. Please refer to P.7.

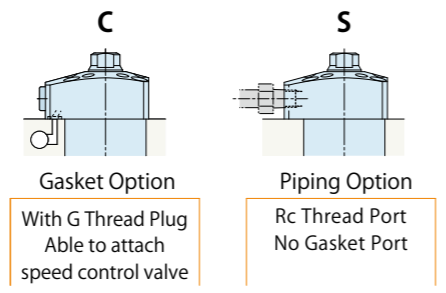

4 Shape of Piston Tip

- A : Female Threaded
- B : Female Threaded (With Anti-Rotation Pinhole)
- T : Male Threaded

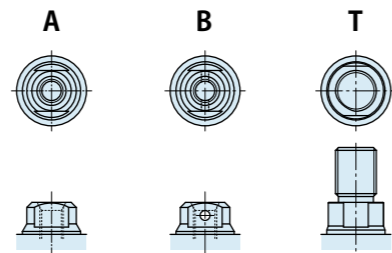

5 Cushioning Position

- B : Both-end Cushioning
- F : Push-end Cushioning Only
- K : Pull-end Cushioning Only

※ Cushioning starting positions as follows:  
Push side:  $5\pm 0.5\text{mm}$  before push end  
Pull side:  $10\pm 0.5\text{mm}$  before pull end  
No function to adjust cushioning strength.

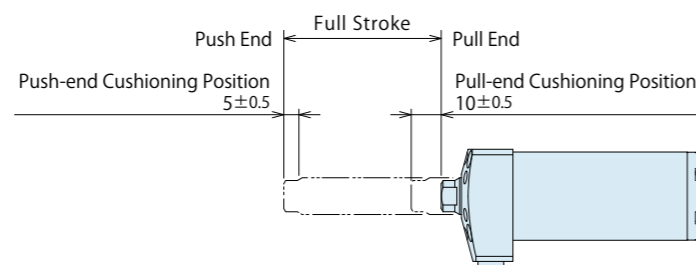

6 Stroke

**Stroke Value** : Full Stroke

※ Specify the full stroke in 5mm increments.  
Example : Full Stroke 50mm : 050  
            Full Stroke 75mm : 075  
            Full Stroke 125mm : 125

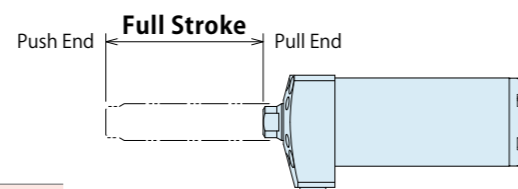

Model No.	LLP0400-□□□	LLP0480-□□□	LLP0550-□□□
Full Stroke	mm 50~100 (in 5mm increments)	50~200 (in 5mm increments)	50~200 (in 5mm increments)

Performance Curve

Model No.	Cylinder Inner Diam. (mm)	Rod Diam. (mm)	Push side Cylinder Area (cm <sup>2</sup> )	Push side Cylinder Output Calc. Formula (kN) <sup>※1</sup>	Pull side Cylinder Area (cm <sup>2</sup> )	Pull side Cylinder Output Calc. Formula (kN) <sup>※1</sup>
LLP0400-□□□-□	$\phi 26$	$\phi 18$	5.3	$F = P \times 0.53$	2.8	$F = P \times 0.28$
LLP0480-□□□-□	$\phi 32$	$\phi 20$	8.0	$F = P \times 0.80$	4.9	$F = P \times 0.49$
LLP0550-□□□-□	$\phi 35$	$\phi 22$	9.6	$F = P \times 0.96$	5.8	$F = P \times 0.58$

Model No.	Cylinder Force (Push Side) (kN)							Cylinder Force (Pull Side) (kN)						
	1MPa	2MPa	3MPa	4MPa	5MPa	6MPa	7MPa	1MPa	2MPa	3MPa	4MPa	5MPa	6MPa	7MPa
LLP0400-□□□-□	0.5	1.0	1.5	2.1	2.6	3.1	3.7	0.2	0.5	0.8	1.1	1.4	1.6	1.9
LLP0480-□□□-□	0.8	1.6	2.4	3.2	4.0	4.8	5.6	0.4	0.9	1.4	1.9	2.4	2.9	3.4
LLP0550-□□□-□	0.9	1.9	2.8	3.8	4.8	5.7	6.7	0.5	1.1	1.7	2.3	2.9	3.4	4.0

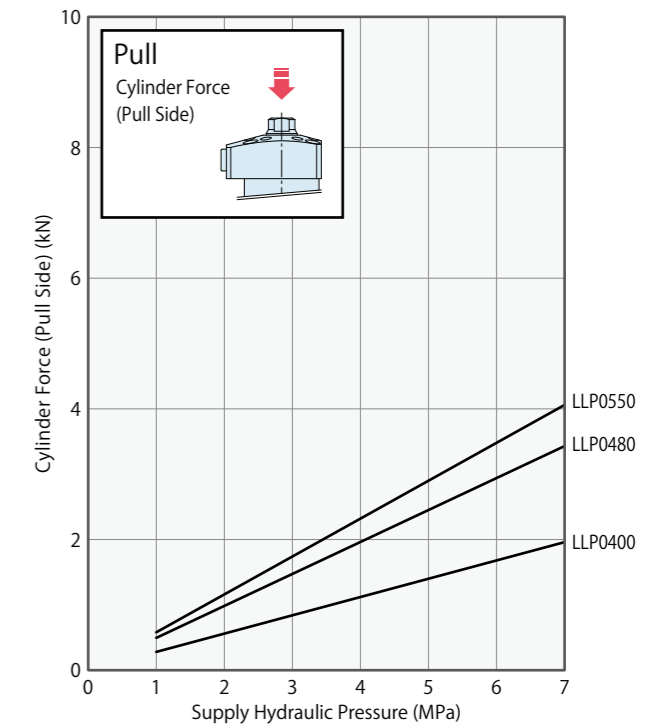
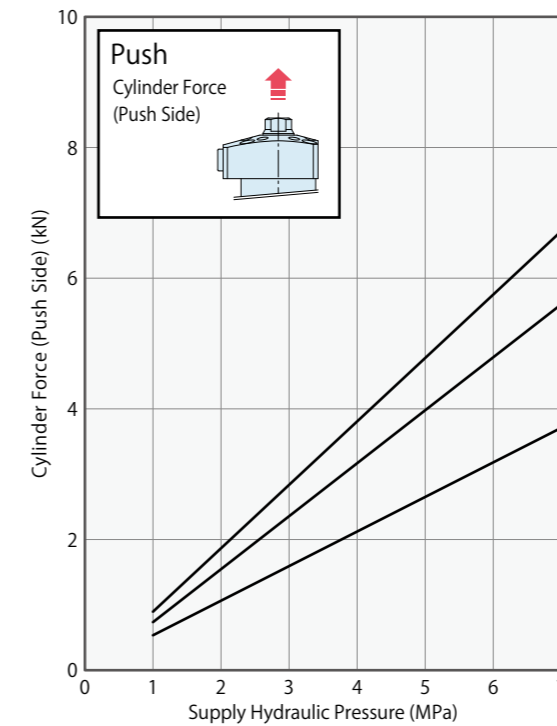

Notes :

- ※1. F : Cylinder Force (kN), P : Supply Hydraulic Pressure (MPa)
- 1. The table and the graph show the relationship between the cylinder force and the supply hydraulic pressure.
- 2. Cylinder force F (kN) is the theoretical value. Actual force may decrease due to sliding friction of the cylinder and pressure loss in the hydraulic device and piping.

**External Dimensions**

C: Gasket Option (with G Thread Plug) **A**: Female Threaded  
 ※This drawing shows LLP-CA□.

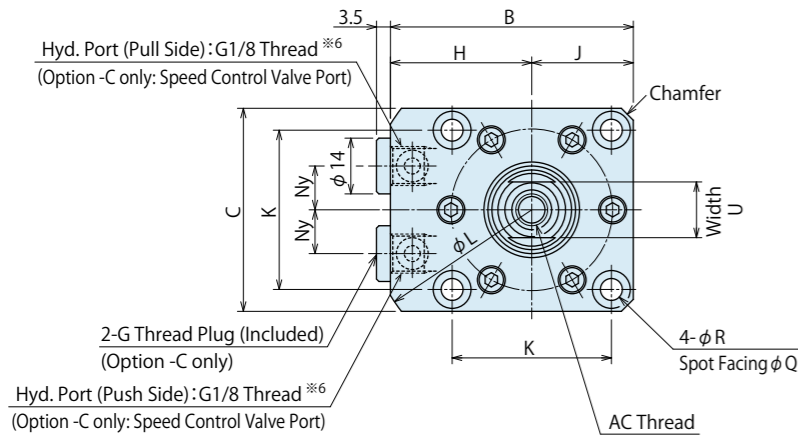

**Machining Dimensions of Mounting Area**

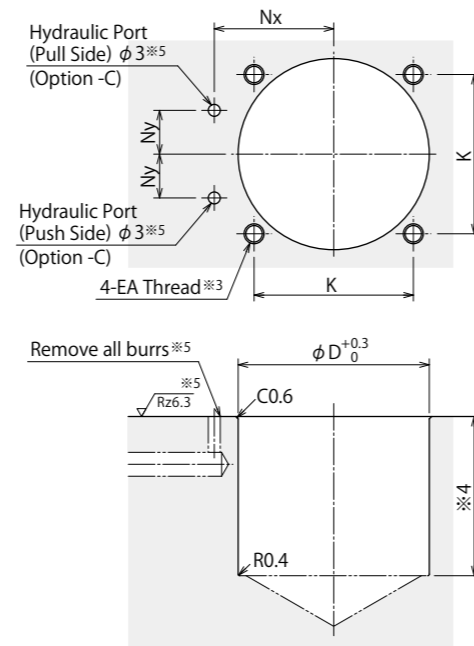

**Specifications**

Model No.	LLP0400-□□□-□	LLP0480-□□□-□	LLP0550-□□□-□	
Full Stroke Y	mm	50 ~ 100	50 ~ 200	50 ~ 200
Cylinder Area	cm <sup>2</sup>	5.3	8.0	9.6
	Push Side	2.8	4.9	5.8
Cylinder Force (Calculation Formula)	kN	P×0.53	P×0.80	P×0.96
	Pull Side	P×0.28	P×0.49	P×0.58
Cylinder Capacity (Calculation Formula)	cm <sup>3</sup>	Y×0.53	Y×0.80	Y×0.96
	Pull Side	Y×0.28	Y×0.49	Y×0.58
Cylinder Inner Diameter	mm	φ26	φ32	φ35
Rod Diameter	mm	φ18	φ20	φ22
Max. Operating Pressure	MPa	7.0		
Min. Operating Pressure	MPa	1.0		
Withstanding Pressure	MPa	10.5		
Operating Temperature	°C	0 ~ 70		
Usable Fluid		General Hydraulic Oil Equivalent to ISO-VG-32		
Weight	kg	1.0 ~ 1.4	1.7 ~ 3.0	2.3 ~ 4.1

Symbols in Cylinder Force (Calculation Formula) and Cylinder Capacity (Calculation Formula) indicate P: Supply Hydraulic Pressure, Y: Full Stroke (mm).

**External Dimensions and Machining Dimensions for Mounting**

**A**: Female Threaded (mm) (Ex.) In case of LLP0400-□A□-□020 [Y=70, A=131, E=121, F=96]

Model No.	LLP0400-□A□-□	LLP0480-□A□-□	LLP0550-□A□-□
Full Stroke Y	50 ~ 100	50 ~ 200	50 ~ 200
A	Y+61	Y+66	Y+69
B	54	61	69
C	45	51	60
D	40	48	55
E	Y+51	Y+55	Y+57
F	Y+26	Y+27	Y+29
G	25	28	28
H	31.5	35.5	39
J	22.5	25.5	30
K	34	40	47
L	73	83	88
M	11	12	12
Nx	26	30	33.5
Ny	9	11	12
Q	9.5	9.5	11
R	5.5	5.5	6.8
S	14	15.5	13
T	10	11	12
U	13	14	17
W	7.5	8.5	9
Chamfer	C3	C3	C3
AB	15	17	19
AC (Nominal×Pitch×Depth)	M8×1.25×16	M8×1.25×16	M10×1.5×20
AE	4	6	4
AF (Nominal×Pitch)	M4×0.7	M4×0.7	M5×0.8
EA (Nominal×Pitch)	M5×0.8	M5×0.8	M6×1

**B**: Female Thread (with Anti-Rotation Pinhole) Refer to **A** Female Threaded for unlisted dimensions. (mm)

Model No.	LLP0400-□B□-□	LLP0480-□B□-□	LLP0550-□B□-□
Vs	2.5	2.5	2.5
Ws	5	6	6.5

**T**: Male Threaded Refer to **A** Female Threaded for unlisted dimensions. (mm)

Model No.	LLP0400-□T□-□	LLP0480-□T□-□	LLP0550-□T□-□
At	Y+81	Y+90	Y+97
Tt	30	35	40
Ut	14	17	17
Vt	20	24	28
Wt	7.5	8.5	9
Cb	17	19	21
CC (Nominal×Pitch)	M12×1.25	M14×1.5	M16×1.5

**Piping Method**

S: Piping Option (Rc Thread)  
 ※The drawing shows LLP-SA□.

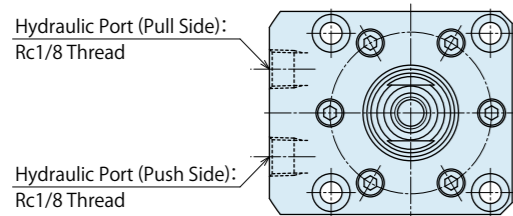

Notes:

- Mounting bolts are not provided. Please prepare them according to the mounting height referring to dimension 'S'.
- The size and the number of AF bolts vary depending on the model.
- EA tapping depth of the mounting bolt should be decided according to the mounting height referring to dimension 'S'.
- The depth of the body mounting hole φD should be decided according to the mounting height referring to dimension 'F'.
- The machining dimension is for -C: Gasket option.
- Speed control valve is sold separately. Please refer to P.7.
- Option F: The cap shape is different.

Model No. Indication (Speed Control Valve for Low Pressure)

**BZL 0 10 1 - B**

1 2 3



1 G Thread Size

10 : Thread Part G1/8A Thread

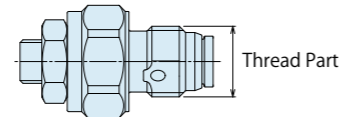

2 Design No.

1 : Revision Number

3 Control Method

B : Meter-out

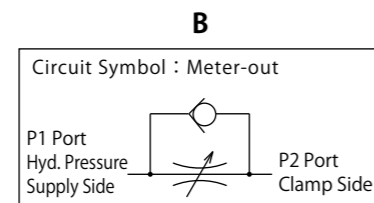

Specifications

Model No.	BZL0101-B	
Max. Operating Pressure	MPa	7
Withstanding Pressure	MPa	10.5
Control Method		Meter-out
G Thread Size		G1/8A
Cracking Pressure	MPa	0.12
Max. Passage Area	mm <sup>2</sup>	2.6
Usable Fluid		General Hydraulic Oil Equivalent to ISO-VG-32
Operating Temperature	°C	0 ~ 70
Tightening Torque for Main Body	N·m	10

- Notes:
1. It must be mounted with recommended torque. Because of the structure of the metal seal, if mounting torque is insufficient, the flow control valve may not be able to adjust the flow rate.
  2. Do not attach a used BZL to other cylinders.  
Flow control may not be done because the bottom depth difference of G thread makes metal sealing insufficient.

Applicable Products

Model No.	LLP (Double Action) Linear Cylinder with Cushion
BZL0101-B	LLP0400-C□□
	LLP0480-C□□
	LLP0550-C□□

- Note:
1. Flow control circuit for double acting cylinder should have meter-out circuits for both the lock and release sides.  
Meter-in control can have adverse effect by presence of air in the system.

Flow Rate Graph < Hydraulic Fluids ISO-VG32 (25~35°C) >

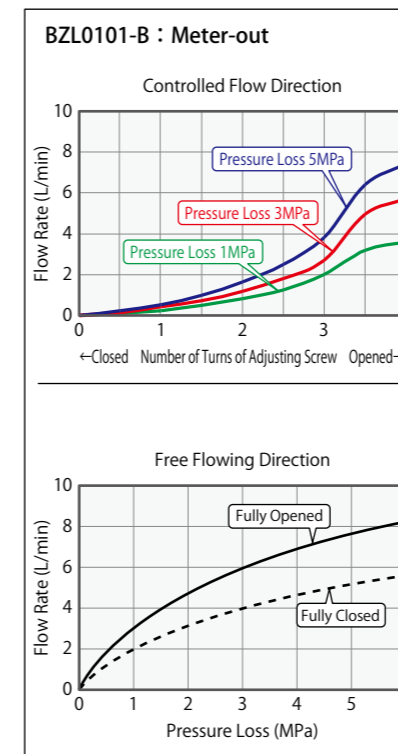

External Dimensions

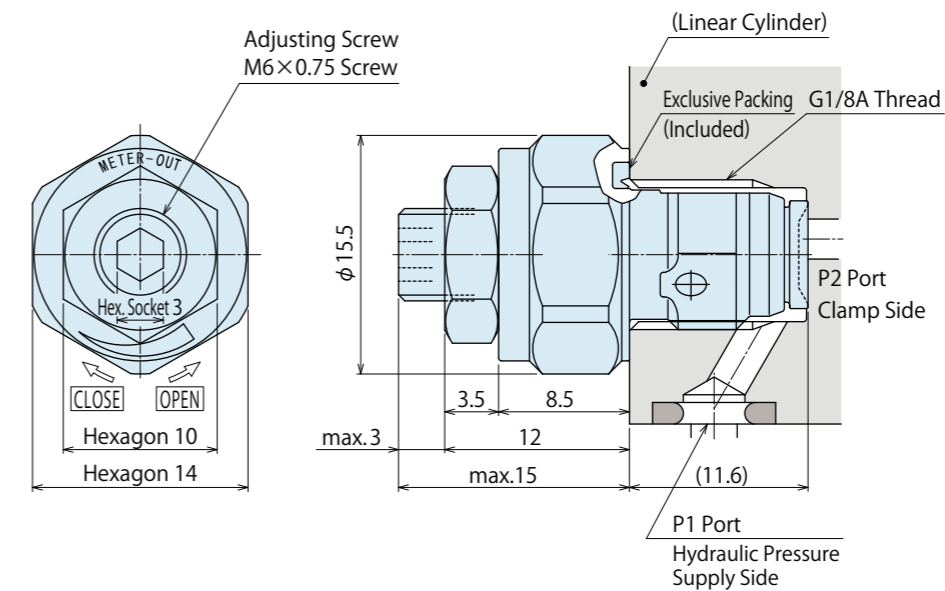

Notes

1. Please read "Notes on Hydraulic Cylinder Speed Control Circuit" to assist with proper hydraulic circuit design.  
If there is something wrong with the circuit design, it leads to the applications malfunction and damage. (Refer to P.11)
2. It is dangerous to bleed air under high pressure. It must be done under low pressure.  
(For reference: the minimum operating range of the product within the circuit.)

**Cautions**

● Notes for Design

- 1) Check Specifications
  - Please use each product according to the specifications.
- 2) Notes for Circuit Design
  - Please read "Notes on Hydraulic Cylinder Speed Control Unit" to assist with proper hydraulic circuit designing. Improper circuit design may lead to malfunctions and damages. (Refer to P.11)
  - Ensure there is no possibility of supplying hydraulic pressure to the push and pull sides simultaneously.
- 3) Notes for Piping Design
  - It is recommended to select as large diameter piping as possible. The back pressure is proportional to the pipe size, so if the piping is small, releasing time and locking time will be longer.
- 4) Protect the exposed area of the piston rod when using on a welding fixture.
  - If spatter gets onto the sliding surface it could lead to malfunction and fluid leakage.
- 5) The Load Direction Given to the Piston Rod
  - Make sure no force is applied to the piston rod except from the axial direction. Usage like the one shown in the figure below will apply a large bending stress to the piston rod and must be avoided.

In case a load is applied except from the axial direction

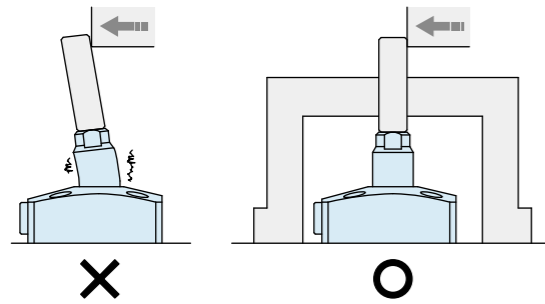

When clamping workpieces of different heights

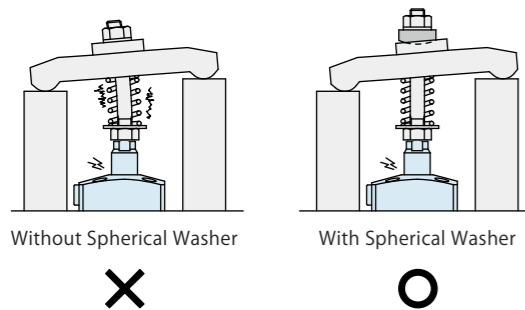

- 6) When Clamping on a Sloped Surface of a Workpiece
  - When clamping an inclined surface, make sure that the clamping area is level when looking from the cylinder side. The clamping surface and the cylinder mounting surface should be parallel. A Workpiece may move and a piston rod may slip when a cylinder is used on a inclined surface. (When the workpiece is a casting, it is recommended that a spiked attachment be used for a clamp on draft angle.)

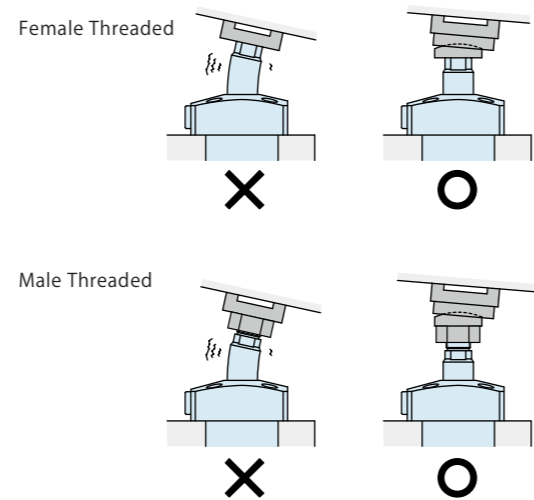

- 7) Anti-Rotation
  - The cylinder has no anti-rotation (stopper) function for piston rod. Install an external anti-rotation function if necessary.
- 8) Notes for Cushioning
  - There is no function to adjust cushioning strength.
- 9) Speed Synchronization
  - Speed of multiple linear cylinders cannot be synchronized.

● Installation Notes

- 1) Check the Usable Fluid
  - Please use the appropriate fluid by referring to the Hydraulic Fluid List.
- 2) Procedure before Piping
  - The pipeline, piping connector and fixture circuits should be cleaned by thorough flushing.
  - The dust and cutting chips in the circuit may lead to fluid leakage and malfunction.
  - There is no filter provided with Kosmek's product except for a part of valves which prevent contamination in the circuit.
- 3) Applying Sealing Tape
  - Wrap with tape 1 to 2 times following the screw direction.
  - Pieces of the sealing tape can lead to oil leakage and malfunction.
  - In order to prevent a foreign substance from going into the product during the piping work, it should be carefully cleaned before working.
- 4) Installation of the Product
  - Use four hexagon socket bolts (with tensile strength of 12.9) and tighten them with the torque shown in the table below. Installation failure leads to oil leak and deformation and damage of the cylinder.

Model No.	Tightening Bolt Size	Tightening Torque (N·m)
LLP0400	M5×0.8	6.3
LLP0480	M5×0.8	6.3
LLP0550	M6×1	10

- 5) Installation / Removal of Attachment
  - When installing or removing an attachment, always use a wrench on the piston rod to keep it from turning, and tighten it with the torque shown below.

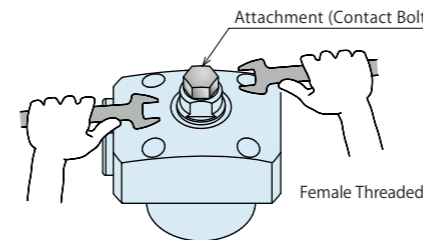

LLP□-□A□ / LLP□-□B□ : Female Threaded

Model No.	Thread Size	Tightening Torque (N·m)
LLP0400-□A□	M8×1.25	16
LLP0480-□A□	M8×1.25	16
LLP0550-□A□	M10×1.5	40

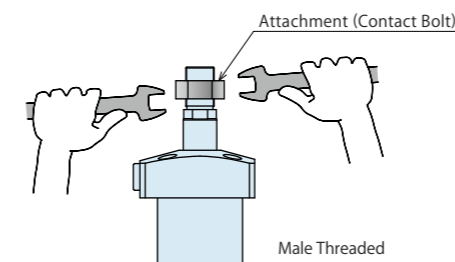

LLP□-□T□ : Male Threaded

Model No.	Thread Size	Tightening Torque (N·m)
LLP0400-□T□	M12×1.25	63
LLP0480-□T□	M14×1.5	80
LLP0550-□T□	M16×1.5	100

- 6) Speed Adjustment
  - Please make sure to release air from the circuit before adjusting speed. It will be difficult to adjust the speed accurately with air mixed in the circuit.
  - Turn the speed control valve gradually from the low-speed side (small flow) to the high-speed side (large flow) to adjust the speed.

7) Air Bleeding of the Hydraulic Circuit

- If the hydraulic circuit has excessive air, there may be no cushioning, or the action time may become very long. If air enters the circuit after connecting the hydraulic port or under the condition of no air in the oil tank, please perform the following steps.

- ① Reduce hydraulic pressure to less than 2MPa.
- ② Bleed the air with G thread plug and R thread plug on the bottom.
- ③ Loosen the cap nut of pipe fitting closest to the clamp by one full turn.
- ④ Wiggle the pipeline to loosen the outlet of pipe fitting. Hydraulic fluid mixed with air comes out.

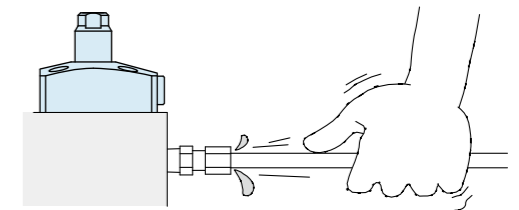

- ⑤ Tighten the cap nut after air bleeding.
- ⑥ It is more effective to bleed air at the highest point inside the circuit or at the end of the circuit. (For the gasket option, set an air bleeding valve at the highest point inside the circuit.)

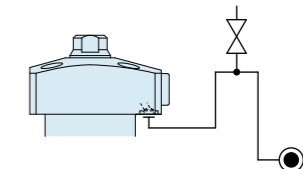

8) Checking Looseness and Retightening

- At the beginning of the product installation, the bolt and nut may be tightened lightly. Check the looseness and re-tighten as required.

● Hydraulic Fluid List

Maker	ISO Viscosity Grade ISO-VG-32	
	Anti-Wear Hydraulic Oil	Multi-Purpose Hydraulic Oil
Showa Shell Sekiyu	Tellus S2 M 32	Morlina S2 B 32
Idemitsu Kosan	Daphne Hydraulic Fluid 32	Daphne Super Multi Oil 32
JX Nippon Oil & Energy	Super Hyrando 32	Super Mulpus DX 32
Cosmo Oil	Cosmo Hydro AW32	Cosmo New Mighty Super 32
ExxonMobil	Mobil DTE 24	Mobil DTE 24 Light
Matsumura Oil	Hydol AW-32	
Castrol	Hyspin AWS 32	

Note As it may be difficult to purchase the products as shown in the table from overseas, please contact the respective manufacturer.

**Cautions**

● Notes on Hydraulic Cylinder Speed Control Unit



Please pay attention to the cautions below. Design the hydraulic circuit for controlling the action speed of hydraulic cylinder. Improper circuit design may lead to malfunctions and damages. Please review the circuit design in advance.

● Speed Control Circuit for Single Acting Cylinder

For spring return single acting cylinders, restricting flow during release can extremely slow down or disturb release action. The preferred method is to control the flow during the lock action only. It is also preferred to provide a flow control valve at each actuator which has limited action speed (swing clamp, hydraulic compact cylinder, etc.)

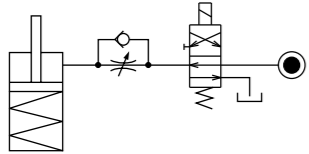

If the cylinder may be damaged by the load from the releasing action direction, provide the flow control valve to the releasing side as well. (Provide the flow control valve to the releasing side if the lever weight is applied during release action.)

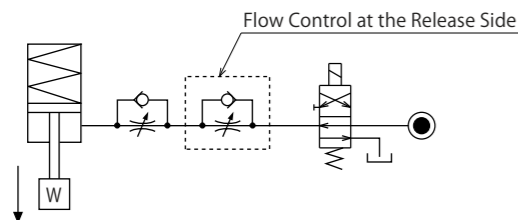

● Speed Control Circuit for Double Acting Cylinder

Speed control circuit for double action cylinder should have meter-out circuits for both the lock and release sides. Meter-in circuits can be adversely affected by any air in the system.

【Meter-out Circuit】

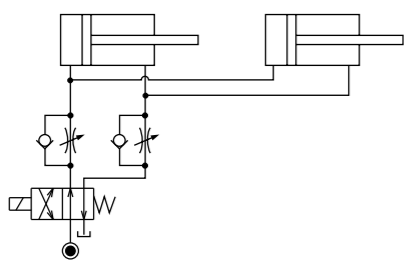

【Meter-in Circuit】

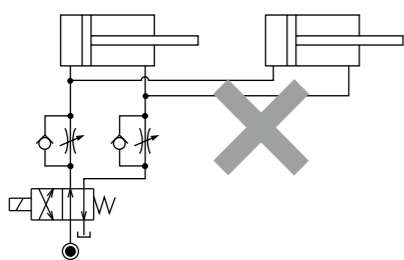

In the case of meter-out circuit, the hydraulic circuit should be designed with the following points.

- ① Single acting components should not be used in the same flow control circuit as the double acting components. The release action of the single acting cylinders may become erratic or very slow.

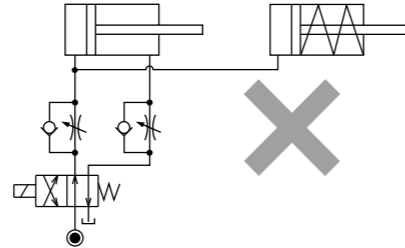

Refer to the following circuit when both the single acting cylinder and double acting cylinder are used together.

- Separate the control circuit.

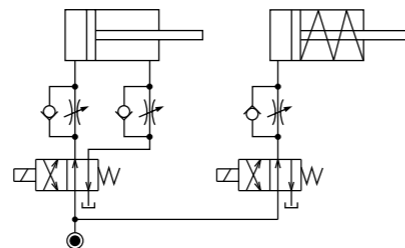

- Reduce the influence of double acting cylinder control unit. However, due to the back pressure in tank line, single acting cylinder is activated after double acting cylinder works.

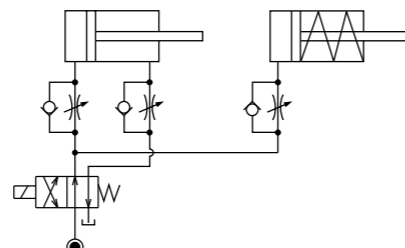

- ② In the case of meter-out circuit, the inner circuit pressure may increase during the cylinder action because of the fluid supply. The increase of the inner circuit pressure can be prevented by reducing the supplied fluid beforehand via the flow control valve. Especially when using sequence valve or pressure switches for clamping detection. If the back pressure is more than the set pressure then the system will not work as it is designed to.

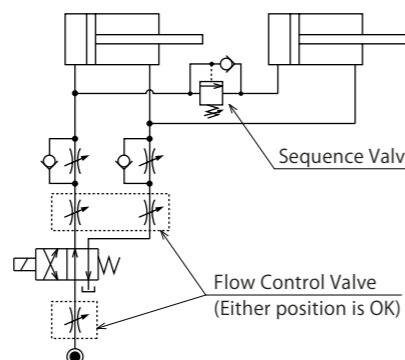

● Notes on Handling

- 1) It should be handled by qualified personnel.
  - The hydraulic machine and air compressor should be handled and maintained by qualified personnel.
- 2) Do not handle or remove the product unless the safety protocols are ensured.
  - ① The machine and equipment can only be inspected or prepared when it is confirmed that the preventive devices are in place.
  - ② Before the product is removed, make sure that the above-mentioned safety measures are in place. Shut off the pressure and power source, and make sure no pressure exists in the air and hydraulic circuits.
  - ③ After stopping the product, do not remove until the temperature drops.
  - ④ Make sure there is no abnormality in the bolts and respective parts before restarting the machine or equipment.
- 3) Do not touch the cylinder while it is working. Otherwise, your hands may be injured due to clincing.

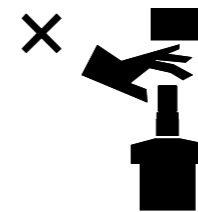

- 4) Do not disassemble or modify.
  - If the equipment is taken apart or modified, the warranty will be voided even within the warranty period.

● Maintenance and Inspection

- 1) Removal of the Product and Shut-off of Pressure Source
  - Before the product is removed, make sure that safety measures and preventive devices are in place. Shut off the pressure and power source, and make sure no pressure exists in the air and hydraulic circuits.
  - Make sure there is no abnormality in the bolts and respective parts before restarting.
- 2) Regularly clean the area around the piston rod.
  - If it is used when the surface is contaminated with dirt, it may lead to packing seal damage, malfunctioning, fluid leakage and air leaks.

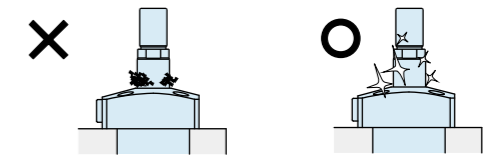

- 3) If disconnecting by couplers, air bleeding should be carried out on a regular basis to avoid air mixed in the circuit.
- 4) Regularly tighten piping, mounting bolts, and etc., to ensure proper use.
- 5) Make sure the hydraulic fluid has not deteriorated.
- 6) Make sure there is smooth action and no abnormal noise.
  - Especially when it is restarted after left unused for a long period, make sure it can be operated correctly.
- 7) The products should be stored in the cool and dark place without direct sunshine or moisture.
- 8) Please contact us for overhaul and repair.

● Warranty

- 1) Warranty Period
  - The product warranty period is 18 months from shipment from our factory or 12 months from initial use, whichever is earlier.
- 2) Warranty Scope
  - If the product is damaged or malfunctions during the warranty period due to faulty design, materials or workmanship, we will replace or repair the defective part at our expense. Defects or failures caused by the following are not covered.
    - ① If the stipulated maintenance and inspection are not carried out.
    - ② If the product is used while it is not suitable for use based on the operator's judgment, resulting in defect.
    - ③ If it is used or handled in inappropriate way by the operator. (Including damage caused by the misconduct of the third party.)
    - ④ If the defect is caused by reasons other than our responsibility.
    - ⑤ If repair or modifications are carried out by anyone other than Kosmek, or without our approval and confirmation, it will void warranty.
    - ⑥ Other caused by natural disasters or calamities not attributable to our company.
    - ⑦ Parts or replacement expenses due to parts consumption and deterioration. (Such as rubber, plastic, seal material and some electric components.)

Damages excluding from direct result of a product defect shall be excluded from the warranty.

MEMO

MEMO





## KOSMEK LTD.

▶ <http://www.kosmek.com/>

HEAD OFFICE 1-5, 2-chome, Murotani, Nishi-ku, Kobe-city, Hyogo, Japan 651-2241  
TEL.+81-78-991-5162 FAX.+81-78-991-8787

United States of America SUBSIDIARY	KOSMEK (USA) LTD. 650 Springer Drive, Lombard, IL 60148 USA TEL. +1-630-620-7650 FAX. +1-630-620-9015
MEXICO REPRESENTATIVE OFFICE	KOSMEK USA Mexico Office Av. Santa Fe #103 int 59 Col. Santa Fe Juriquilla C.P. 76230 Queretaro, Qro Mexico TEL. +52-442-161-2347
EUROPE SUBSIDIARY	KOSMEK EUROPE GmbH Schleppeplatz 2 9020 Klagenfurt am Wörthersee Austria TEL. +43-463-287587 FAX. +43-463-287587-20
CHINA SUBSIDIARY	KOSMEK (CHINA) LTD. Room601, RIVERSIDE PYRAMID No.55, Lane21, Pusan Rd, Pudong Shanghai 200125, China TEL. +86-21-54253000
INDIA BRANCH OFFICE	KOSMEK LTD. - INDIA F 203, Level-2, First Floor, Prestige Center Point, Cunningham Road, Bangalore -560052 India TEL.+91-9880561695
THAILAND REPRESENTATIVE OFFICE	KOSMEK Thailand Representation Office 67 Soi 58, RAMA 9 Rd., Suanluang, Suanluang, Bangkok 10250, Thailand TEL. +66-2-300-5132 FAX. +66-2-300-5133



WAHLTEC GmbH  
Ravensburger Str. 14  
88361 Altshausen  
T: +49 (7584) 9238883  
F: +49 (7584) 9238887

[www.wahltec.de](http://www.wahltec.de)

- For Further Information on Unlisted Specifications and Sizes, Please call us.
- Specifications in this Leaflet are Subject to Change without Notice.



JQA-QMA10823  
KOSMEK HEAD OFFICE